

802.11ah
Wi-Fi HaLow™
Access Point
AP-100AH

User's Manual



Index

I. Introduction	1
1-1. Introduction	1
Disclaimers	1
Trademarks	1
1-2. Safety Instructions	2
1-3. Product Information and Customer Services	5
Product Information	5
Customer Support Center	5
2. About AP-100AH	6
2-1. Features	7
2-2. Parts and Functions	9
2-3. Hardware Specification	11
2-4. Software Specification	14
2-5. Use of Radio Waves	14
Notes on Usage	14
2-6. Notes on Security	15
3. AP-100AH Setup	16
3-1. Configuration Using AP-100AH's Web Page	17
Connecting AP-100AH to a computer	17
Configuration	18
Connecting to Network	23
3-2. Configuration Using AMC Manager®	24
Connecting AP-100AH to a computer	24
Configuration	25
Connecting to Network	29
4. List of Functions	30
4-1. DHCP Client	30
4-2. Network Address Translation (NAT)	30
4-3. Radio Configuration	32
4-4. IP Access Control	33
4-5. Web (HTTP/HTTPS)	34
4-4. Maintenance	35
Restarting	35
Factory Default Configuration	38
Firmware Update	41
A. Appendix	44
A-1. List of All Settings	44
A-2. Troubleshooting	53



1. Introduction

Thank you for purchasing the Wireless Access Point AP-100AH (hereinafter the "AP-100AH").

1-1. Introduction

This manual provides information on how to configure and use the AP-100AH. Please read the Safety Instructions carefully before you begin.

Disclaimers

- The unauthorized transfer or copying of the content of this manual, in whole or in part, without prior written consent is expressly prohibited by law.
- The content of this manual is subject to change without notice.
- This manual was prepared to accurately match the content of each OS, but the actual information shown on the computer monitor may differ from the content of this manual due to future OS version upgrades, modifications, and other changes.
- Although every effort was made to prepare this manual with the utmost accuracy, Silex Technology will not be held liable for any damages as a result of errors, setting examples, or other content.

Trademarks



- Microsoft and Windows are registered trademarks of Microsoft Corporation in the United States and/or other countries.
- Wi-Fi, Wi-Fi Protected Setup (WPS), Wi-Fi Protected Access (WPA), WPA2, WPA3 are trademarks or registered trademarks of Wi-FiAlliance.
- Other company names and product names contained in this manual are trademarks or registered trademarks of their respective companies.

1-2. Safety Instructions







This page provides the safety instructions for safe use of AP-100AH.

To ensure safe and proper use, please read the following information carefully before using AP-100AH. The safety instructions include important information on safe handling of AP-100AH and on general safety issues.

< Meaning of the warnings >





	Warning	"Warning" indicates the existence of a hazard that could result in death or serious injury if the safety instruction is not observed.
	Caution	"Caution" indicates the existence of a hazard that could result in serious injury or material damage if the safety instruction is not observed.

< Meaning of the symbols >

	This symbol indicates the warning and caution. (Example:  "Danger of the electric shock")
	This symbol indicates the prohibited actions. (Example:  "Disassembly is prohibited")
	This symbol indicates the actions users are required to observe. (Example:  "Remove the AC plug from an outlet")



Warning

 	<p>* Do not allow physical impact. When damaged, turn off the connected devices, unplug the AC plug of AP-100AH from a power outlet and contact your point of purchase. Failure to take this action could cause fire or an electrical shock.</p> <p>* In the following cases, turn off the connected devices and unplug the AC plug of AP-100AH from a power outlet and contact your point of purchase. Failure to take this action could cause fire or an electrical shock.</p> <ul style="list-style-type: none"> * When AP-100AH emits a strange smell, smoke or sound or becomes too hot to touch. * When foreign objects (metal, liquid, etc.) gets into AP-100AH.
	<p>* Keep the cords and cables away from children. It may cause an electrical shock or serious injury.</p>
	<p>* If a ground wire is supplied with your device to use with, connect it to the ground terminal in order to prevent an electrical shock. Do not connect the ground wire to gas pipe, water pipe, lighting rod or telephone ground wire. It may cause malfunction.</p>
	<p>* Do not disassemble or modify AP-100AH. It may cause fire, electrical shock or malfunction.</p> <p>* Do not disassemble or modify the AC adaptor that came with AP-100AH. It may cause fire, electrical shock or malfunction.</p>



Caution

	<p>* Do not pull on the cord to disconnect the plug from the power supply. The cord may be broken, which could result in fire or an electrical shock.</p>
	<p>* When removing AP-100AH, disconnect the AC plugs of both AP-100AH and the other devices you are using with.</p> <p>* Use the AC adaptor supplied with AP-100AH. Other AC adaptors may cause malfunction.</p> <p>* Verify all codes or cables are plugged correctly before using AP-100AH.</p> <p>* When AP-100AH will not be used for a long time, unplug the power cables of AP-100AH and the other devices you are using with.</p>
	<p>* Do not use or store AP-100AH under the following conditions. It may cause malfunction.</p> <ul style="list-style-type: none">- Locations subject to vibration or shock- Shaky, uneven or tilted surfaces- Locations exposed to direct sunlight- Humid or dusty places- Wet places (kitchen, bathroom, etc.)- Near a heater or stove- Locations subject to extreme changes in temperature- Near strong electromagnetic sources (magnet, radio, wireless device, etc.)

1-3. Product Information and Customer Services

Product Information

The services below are available from the Silex Technology website. For details, please visit the Silex Technology website.

URL	
USA / Europe	https://www.silextechnology.com/

- Latest firmware download
- Latest software download
- Latest manual download

Customer Support Center

Customer Support is available by e-mail or telephone for any problems that you may encounter. If you cannot find the relevant problem in this manual or on our website, or if the corrective procedure does not resolve the problem, please contact Silex Technology Customer Support.

Contact Information		
USA	+1-657-218-5199	support@silexamerica.com
Europe	+49-2154-88967-0	support@silexeurope.com



Note

- Visit the Silex Technology website (<https://www.silextechnology.com/>) for the product information.

2. About AP-100AH

AP-100AH is a wireless access point that supports 802.11ah and can be used as a base station to connect your wireless client devices to each other. With sub-GHz radio, the AP-100AH establishes a wide-range Wi-Fi network with up to 234 802.11ah client devices, avoiding interfering with 2.4GHz/5GHz radios from the legacy Wi-Fi network.

The AP-100AH employs WPA3 Wi-Fi authentication to ensure safe and secure wireless communication at an office, factory, etc. where higher security is required. The AP-100AH is firmware upgradable to enhance its feature.

2-1. Features

AP-100AH has the following features:

Robust long range IoT network enabled by IEEE 802.11ah Wi-Fi HaLow®

AP-100AH establishes a wireless local area network (WLAN) with sub-GHz radio. 802.11ah provides a much longer range than 2.4GHz/5GHz, much more device connections per access point, radio interference avoidance with 2.4GHz/5GHz radios, and much better radio coverage due to better wall penetration and diffraction around obstacles.

Seamless deployment to an existing network

The AP-100AH deploys 802.11ah wireless network into an existing IP network seamlessly. If your wireless network suffers from a congested 2.4GHz radio environment, reallocating many devices from 2.4GHz network to sub-GHz network will relieve your 2.4GHz radio congestion and add scalability to a large amount of IoT network for the future.

Advanced security

The following security features are supported:

- Enhanced Open (OWE, AES-128)
- WPA2-Personal (PSK, AES-128)
- WPA3-Personal (SAE, AES-128)

A large amount of client device connections

The AP-100AH supports up to 234 802.11ah wireless device connections.

NAT capable access point

The AP-100AH supports Network Address Translation (NAT) to build a private 802.11ah wireless network and bridge it to the other IP network on the Ethernet port. The feature allows building a large IoT network within the available IPv4 resources.

Firmware upgradable device

- The AP-100AH support the firmware update to enhance its features. The firmware update is easy through its configuration web page or AMC Manager®.

Easy access to the Web configuration interface

The Web configuration interface of AP-100AH can easily be accessed.

AMC Manager (non-free program)

AP-100AH supports the total management software, AMC Manager® version 4.0.0 and later. The AMC Manager® provides useful features, as follows:

- Remote device control and monitoring
- Bulk configuration and firmware updates
- System time synchronization (version 4.0.0 or later)



Note

- To use the functions above, your Access Point or wireless router needs to support the same functions.
- For details on the "AMC Manager", please visit our homepage.
- To use the "AMC Manager", an IP address needs to be configured to the AP-100AH.
- AP-100AH can be used in Infrastructure mode only. Ad hoc mode is not supported.

2-2. Parts and Functions

The parts name and functions are as follows:

Top

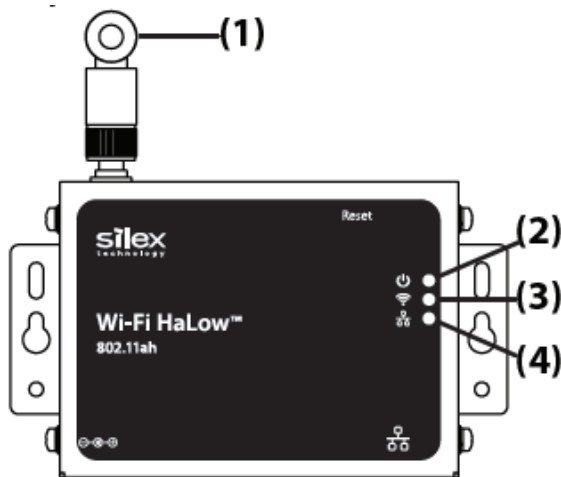

(1)	Wireless LAN Antenna	Antenna for wireless communication	
(2)	Power LED (Orange)*	ON	Powered on
(3)	Wireless LED (Yellow)*	ON	STA(s) (station) is (are) connected.
		BLINK	Data communication is occurring.
(4)	Wired LED (Green)*	ON	Wired LAN port is enabled.

* All 3 LEDs (Power/Wireless/Wired LEDs) turn on when the AP-100AH is turned on.

Then, Wireless/Wired LEDs turn off in 1 second, and start to turn on/blink as described in the table.

Front and Back

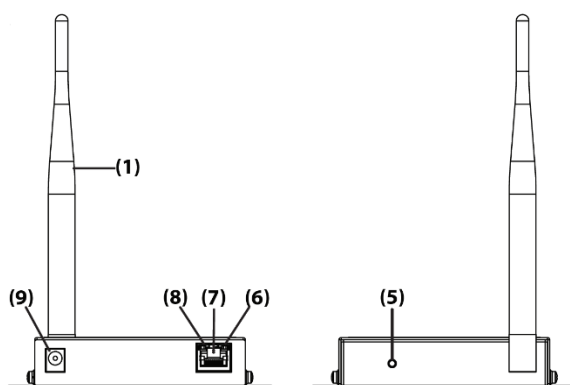

(5)	Push Switch	Press this switch for the following operations when AP-100AH is on.	
		Initialization	Press and hold, and release the switch in 5 sec or longer.
		Restart	Press and hold, and release the switch in 5 sec or shorter
(6)	STATUS LED (Yellow)	Blinks while communicating in a wired LAN	
(7)	Network Port	Connect a network cable.	
(8)	Link LED (Green)	Turns on when connected to a wired LAN.	
(9)	DC Connector	Connect an AC adaptor	

Bottom

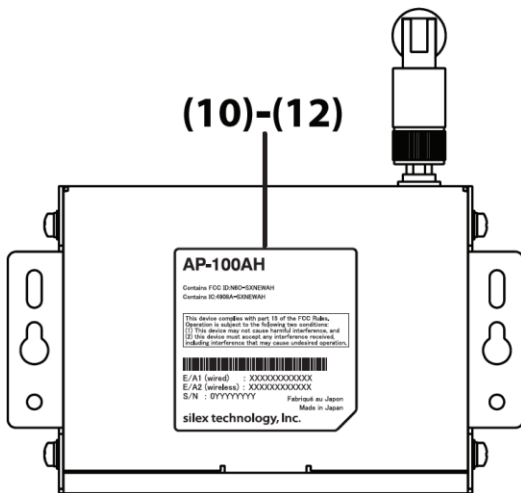

(10)	E/A1 (wired)	Ethernet Address of the wired LAN
(11)	E/A2 (wireless)	Ethernet Address of the wireless LAN
(12)	S/A	Serial Number

2-3. Hardware Specification

Operating environment	Temperature : 0 degrees to +40 degrees
	Humidity : 20% to 80%RH (Non-condensing)
Storage environment	Temperature : -20 degrees to +80 degrees
	Humidity : 20% to 90%RH (Non-condensing)
EMI	FCC Class B
	ICES Class B
Wired network interface	10BASE-T/100BASE-TX (Auto-sensing) :1 port Auto MDI/MDIX
Wireless network interface	IEEE 802.11ah
Channel	(US/CA): Unit MHz 1MHz Bandwidth: 903.5, 904.5, 905.5, 906.5, 907.5, 908.5, 909.5, 910.5, 911.5, 912.5, 913.5, 914.5, 915.5, 916.5, 917.5, 918.5, 919.5, 920.5, 921.5, 922.5, 923.5, 924.5, 925.5, 926.5 2MHz Bandwidth: 905, 907, 909, 911, 913, 915, 917, 919, 921, 923, 925 4MHz Bandwidth: 910, 914, 918, 922
Push Switch	1
LED	Top POWER (Orange) Wireless (Yellow) Wired (Green)
	LAN Port Status (Orange) Link (Yellow)
Compatible devices	Network devices with LAN port (RJ-45)
Maximum number of client device connections	234 devices

FCC / ISED Notice

FCC Notice

AP-100AH

This device complies with Part 15 of FCC Rules. Operation is subject to the following two conditions: (1) this device may not cause harmful interference, and (2) this device must accept any interference received, including interference that may cause undesired operation.

silex technology america, Inc.
201 East Sandpointe, #245
Santa Ana, CA 92707
USA
Phone: 657-218-5199

FCC CAUTION

Changes or modifications not expressly approved by the party responsible for compliance could void the user's authority to operate the equipment.

Contains FCC ID : N6C-SXNEWAH

FCC Rules Part 15 Subpart B

Note: This equipment has been tested and found to comply with the limits for a Class B digital device, pursuant to part 15 of the FCC Rules. These limits are designed to provide reasonable protection against harmful interference in a residential installation. This equipment generates, uses and can radiate radio frequency energy and, if not installed and used in accordance with the instructions, may cause harmful interference to radio communications. However, there is no guarantee that interference will not occur in a particular installation. If this equipment does cause harmful interference to radio or television reception, which can be determined by turning the equipment off and on, the user is encouraged to try to correct the interference by one or more of the following measures:

- Reorient or relocate the receiving antenna.
- Increase the separation between the equipment and receiver.
- Connect the equipment into an outlet on a circuit different from that to which the receiver is connected.
- Consult the dealer or an experienced radio/TV technician for help.

RF exposure compliance

This equipment complies with FCC radiation exposure limits set forth for an uncontrolled environment and meets the FCC radio frequency (RF) Exposure Guidelines. This equipment should be installed and operated keeping the radiator at least 20cm or more away from person's body.

Co-Location Rule

This transmitter must not be co-located or operated in conjunction with any other antenna or transmitter.

Antennas

To prevent violation of the law, do not use antennas other than those provided or specified by Silex Technology.

ISED Notice

This device contains license-exempt transmitter(s)/receiver(s) that comply with Innovation, Science and Economic Development Canada's license-exempt RSS(s). Operation is subject to the following two conditions:

1. This device may not cause interference.
2. This device must accept any interference, including interference that may cause undesired operation of the device.

L'émetteur/récepteur exempt de licence contenu dans le présent appareil est conforme aux CNR d'Innovation, Sciences et Développement économique Canada applicables aux appareils radio exempts de licence. L'exploitation est autorisée aux deux conditions suivantes :

1. L'appareil ne doit pas produire de brouillage;
2. L'appareil doit accepter tout brouillage radioélectrique subi, même si le brouillage est susceptible d'en compromettre le fonctionnement.

Contains IC: 4908A-SXNEWAH**RF exposure considerations**

This equipment complies with ISED radiation exposure limits set forth for an uncontrolled environment and meets RSS-102 of the ISED radio frequency (RF) Exposure rules.

This equipment should be installed and operated keeping the radiator at least 20cm or more away from person's body.

Cet équipement est conforme aux limites d'exposition aux rayonnements énoncées pour un environnement non contrôlé et respecte les règles d'exposition aux fréquences

radioélectriques (RF) CNR-102 de l'ISDE. Cet équipement doit être installé et utilisé en gardant une distance de 20 cm ou plus entre le radiateur et le corps humain.

Antenna Type

This radio transmitter (4908A-SXNEWAH) has been approved by Innovation, Science and Economic Development Canada to operate with the antenna types listed below, with the maximum permissible gain indicated. Antenna types not included in this list that have a gain greater than the maximum gain indicated for any type listed are strictly prohibited for use with this device.

Antenna type	Gain	Impedance
Rod Antenna	3.4dBi	50ohms

Le présent émetteur radio (4908A-SXNEWAH) a été approuvé par Innovation, Sciences et Développement économique Canada pour fonctionner avec les types d'antenne énumérés ci-dessous et ayant un gain admissible maximal. Les types d'antenne non inclus dans cette liste, et dont le gain est supérieur au gain maximal indiqué pour tout type figurant sur la liste, sont strictement interdits pour l'exploitation de l'émetteur.

Type d'antenne	Gain	l'impédance
Antenne à tige	3.4dBi	50ohms

2-4. Software Specification

TCP/IP	Network layer	ARP, IP
	Transport layer	TCP, UDP
	Application layer	HTTP/HTTPS, TFTP, SNMP, DHCP (simple server function only), SX_SMP * SX_SMP are the silex proprietary protocols.

2-5. Use of Radio Waves

Notes on Usage

If there is reinforced metal between wireless devices, they may not connect.

AP-100AH can connect through wood or glass, but may have troubles connecting through reinforced metal.

AP-100AH complies with the certification of conformance to technical standards. Please pay attention to the following points:

- Please do not disassemble or remodel the product. Such action is prohibited by law.
- Please do not remove the certificate label. Using the product without a label is prohibited.

Wireless devices using sub-GHz band

- Before you use AP-100AH, check that it does not interfere with other devices.
- If interference occurs, stop using AP-100AH or change the wireless band. Please consider to create a wall between these devices to avoid interference. Contact us for possible solution.

2-6. Notes on Security

Because a wireless LAN uses electromagnetic signals instead of a network cable to establish communication with network devices, it has the advantage of allowing devices to connect to the network easily. However, a disadvantage of this is that within a certain range, the electromagnetic signals can pass through barriers such as walls, and if security countermeasures are not implemented in some way, problems such as the following may occur.

- Communication is intercepted by a third party
- Unauthorized access to the network
- Leakage of personal information (ID and Card information)
- Spoofing and the falsification of intercepted data
- System crashes and data corruption

Nowadays, wireless LAN cards or access points are equipped with security measures that address such security problems, so that you can enable security-related settings for wireless LAN products in order to reduce the likelihood of problems occurring.

We recommend that you make yourself fully acquainted with the possible implications of what might happen if you use a wireless product without enabling security features, and that you configure security-related settings and use wireless products at your own responsibility.

3. AP-100AH Setup

This chapter explains how to configure the AP-100AH.

Following configuration methods are available:

- 1) Configuration using AP-100AH's web page
- 2) Configuration using AMC Manager®

3-1. Configuration Using AP-100AH's Web Page

How to configure AP-100AH using a web page is explained.

Connecting AP-100AH to a computer

1. Connect AP-100AH and the PC (to use for setup) using a network cable.

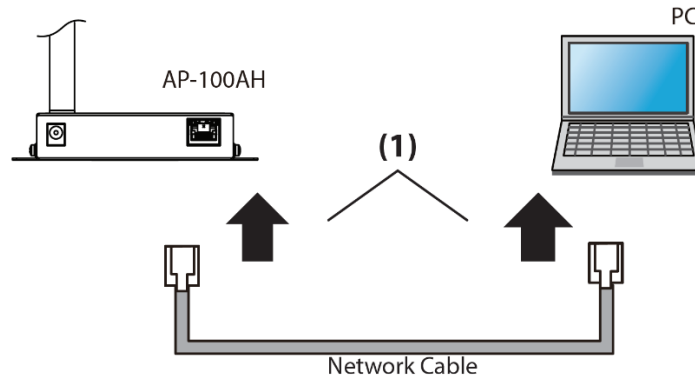

2. Connect the AC adaptor to AP-100AH, and the AC adaptor's plug to an electrical outlet.

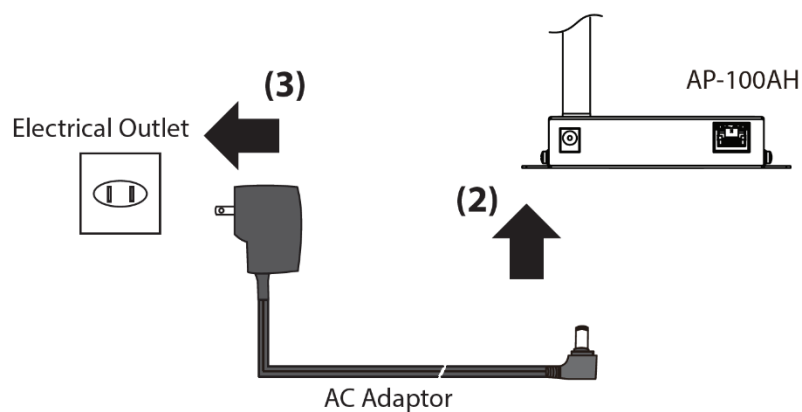

3. Confirm that the Power LED (orange: (2)) and the wired LED (green: (4)) are turned on.



Configuration

1. Access to AP-100AH's web page. Launch a web browser on the PC and enter the IP address of AP-100AH in the address bar. The default IP address of the AP-100AH's Ethernet port is "169.254.111.111".

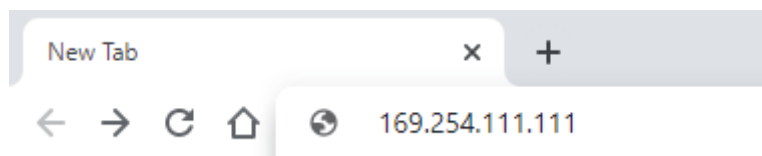

- To start the configuration, the PC and AP-100AH need to communicate each other properly.
- Confirm that an IP Address is correctly configured to the PC.
- If a static IP address is set to the Ethernet adapter of the PC, the Web configuration interface cannot be displayed in the following cases:
 - An IP address of the Ethernet adapter is set for a different subnet.
- If the AP-100AH configuration web page does not appear, set the IP address of the Ethernet adapter of the PC connected with the AP-100AH as following:

IP Address: 169.254.111.1

Subnet Mask: 255.255.0.0

- The login password configuration page appears for the first time web page access. Enter the password to configure for the AP-100AH and click **Submit**. Note that the AP-100AH accepts up to eight letters for the password.

The screenshot shows the 'Welcome to AP-100AH' page. The main content area is titled 'Please set a login password for this unit.' It contains a form with two input fields: 'Password : []' and 'Confirm Password : []'. Below the 'Confirm Password' field, it says '8 letters(max.)'. To the left of the form is a 'Select Language : English' dropdown menu. To the right is a 'Submit' button. At the bottom left, the version information is 'Ver BB3-1.00 (2020.11.30)' and '84-25-3F-01-5E-13'. At the bottom right, it says 'Copyright(C) 2020 silex technology, Inc.'.

- Click **Login** from the left menu and enter the password. Then, click **Login**.

The screenshot shows the 'Login' page. On the left is a navigation menu with the 'silex technology' logo and a 'Select Language' dropdown set to 'English'. The menu items are: Status, System, Station list, Login (circled in red), and silex Global Site. The main content area is titled 'Login' and has a sub-header 'Authentication is required'. Below this is a form with a 'Please input the password' label and a 'Password : []' input field. To the right of the input field is a 'Login' button (circled in red). A 'HELP' icon is in the top right corner. At the bottom left, the version information is 'Ver BB3-1.00 (2020.11.30)' and '84-25-3F-01-5e-14'. At the bottom right, it says 'Copyright(C) 2020 silex technology, Inc.'.

4. In the Web configuration interface, click **Wireless LAN** from the left menu. Change **SSID**, **channel bandwidth**, **Channel**, **Tx Power**, and **Network Authentication** as your requirement. When WPA2-Personal or WPA3-Personal is selected as the network authentication, **Pre-Shared Key** configuration appears. Click **Submit** once the parameters are set.

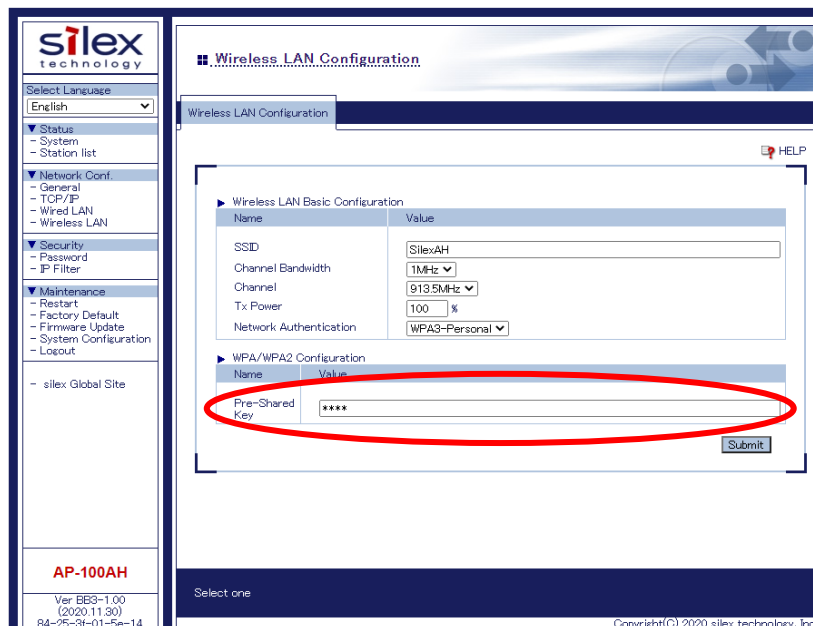
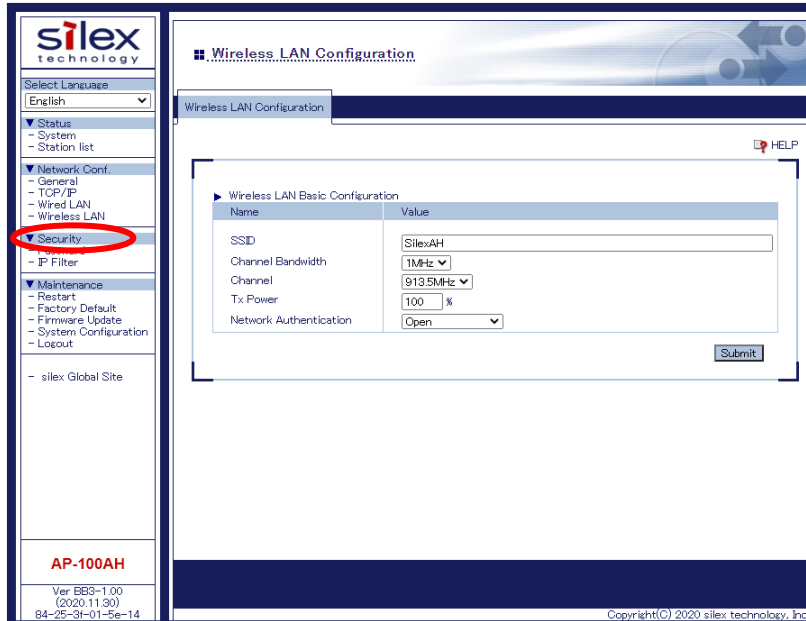

Note

- SSID must be 1 – 32 characters with alphanumeric, hyphen or underscore.
- Pre-Shared Key must be 8 – 63 characters password or 64 hexadecimal for WPA2-Personal or 8 – 63 characters password for WPA3-Personal

5. Click **TCP/IP** and change the configuration as your need. By default, DHCP is set to **AUTO**, which allows the AP-100AH to obtain its IP address from a DHCP server if available. When a DHCP is not available, the IP address in **Value** is used as a static IP address.

NAT is also enabled in default. If you do not need NAT function for your installation, select **OFF** in **NAT mode enable**.

The screenshot displays the Silex Technology web interface for the AP-100AH. The main content area is titled "TCP/IP Configuration" and is divided into three sections:

- TCP/IP Configuration:** A table with columns "Name", "Current Value", and "Value".

Name	Current Value	Value
DHCP		AUTO
IP Address	169.254.111.111	169.254.111.111
Subnet Mask	255.255.0.0	255.255.0.0
Default Gateway	0.0.0.0	0.0.0.0
DNS Server (Primary)	0.0.0.0	0.0.0.0
DNS Server (Secondary)	0.0.0.0	0.0.0.0
- NAT configuration:** A table with columns "Name" and "Value".

Name	Value
NAT mode enable	ON
Wireless IP Address	192.168.1.1
Wireless Subnet Mask	255.255.255.0
DHCP Start IP Address	192.168.1.21
DHCP End IP Address	192.168.1.254
DHCP Lease Time	10 Days 0 Hours 0 Minutes
- IP Protocol Configuration:** A table with columns "Name" and "Value".

Name	Value
Protocols which are checked are enabled.	<input checked="" type="checkbox"/> HTTP(80) NOTE: Disabling HTTP will prevent access to this server via the browser interface. <input checked="" type="checkbox"/> HTTPS(443) NOTE: Disabling HTTP will prevent access to this server via the browser interface. <input type="checkbox"/> TFTP(69) <input checked="" type="checkbox"/> SNMP(161)

The left sidebar contains navigation options: Select Language (English), Status (System, Station list), Network Conf. (General, TCP/IP, Wired LAN, Wireless LAN), Security (Password, IP Filter), Maintenance (Restart, Factory Default, Firmware Update, System Configuration, Logout), and silex Global Site. The bottom of the page shows "AP-100AH", version "Ver BB3-1.00 (2020.11.30)", and "84-25-3f-01-5e-14". The footer indicates "Copyright(C) 2020 silex technology, Inc."

When you use HTTPS protocol to access to the web configuration page after the initial configuration, load **CA Certificate**, **Local Certificate** and **Local Private Key**.

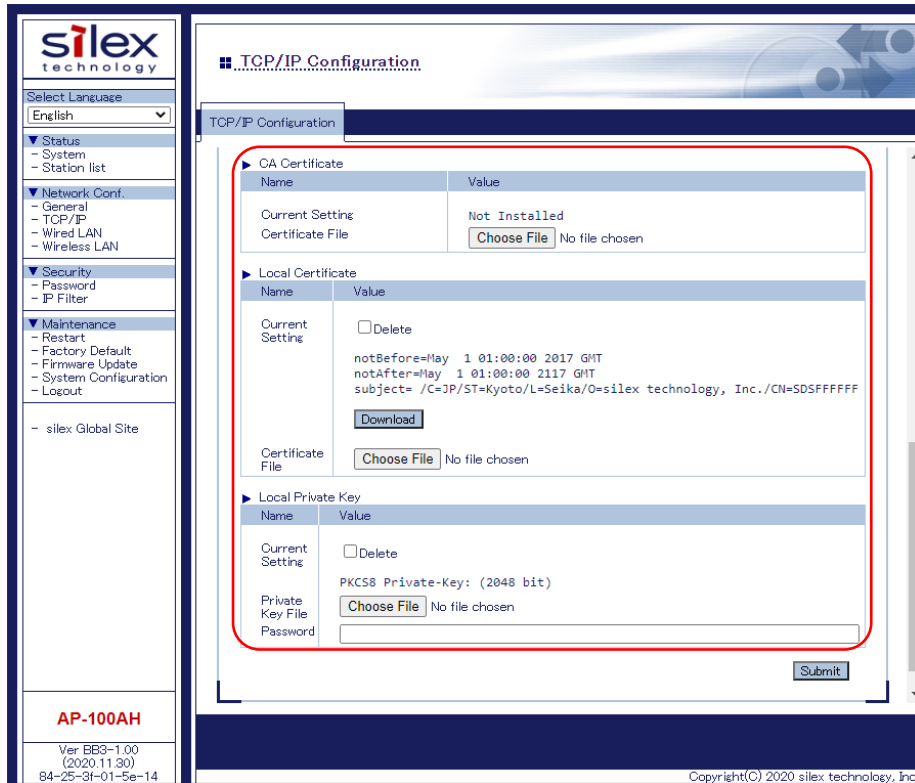

- Click **Restart** and **Yes** to restart the BR-100AH. The configuration set in the step 4 takes effect only after the BR-100AH is restarted.

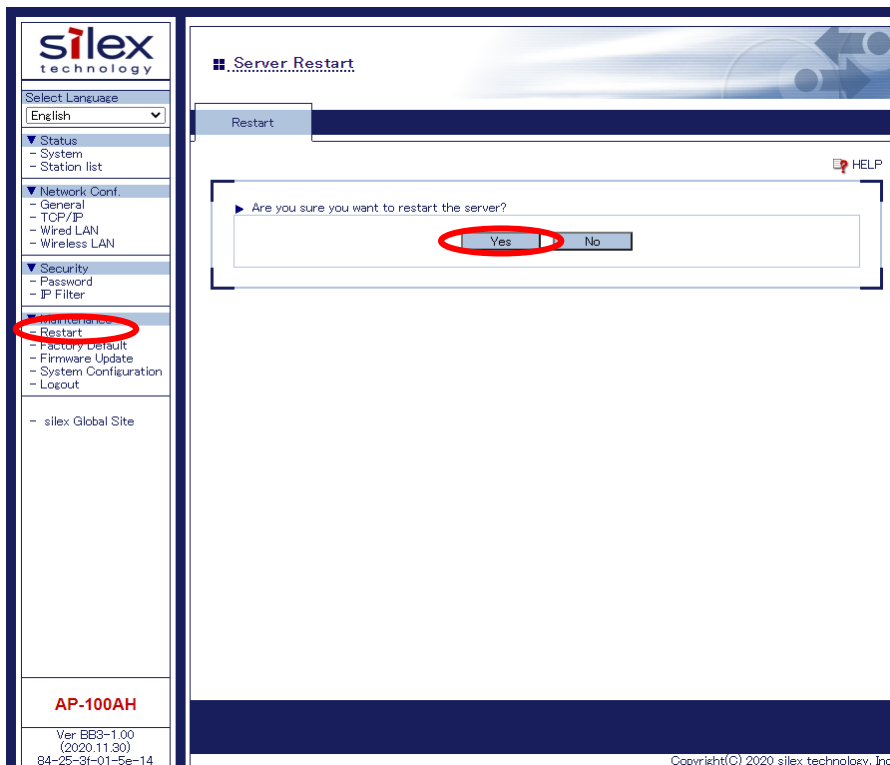

Connecting to Network

1. Connect the AP-100AH with an Ethernet HUB, switch, or a router. Note that the figure below only shows an Ethernet HUB, but it does not mean the AP-100AH works only with an Ethernet HUB.

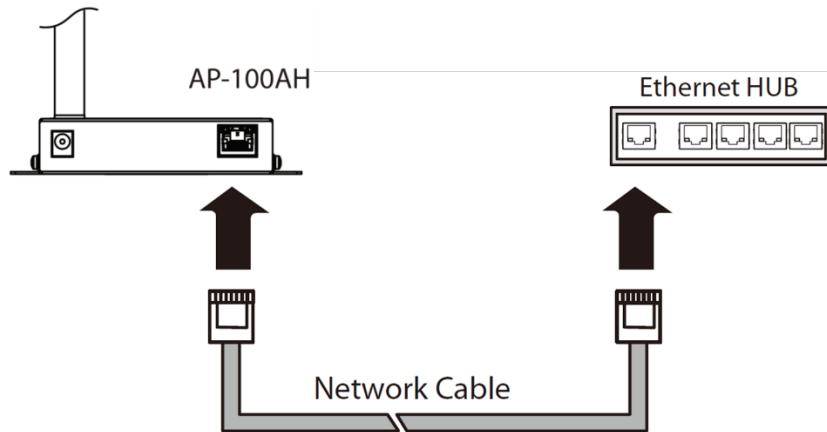

2. Connect the AC adaptor to the AP-100AH and the AC plug to the outlet.

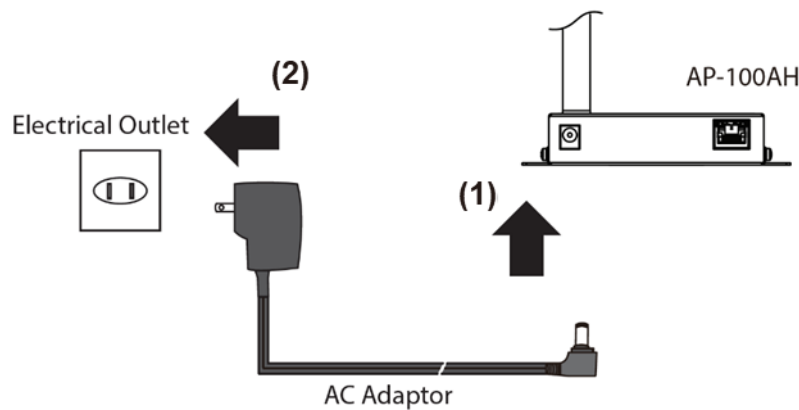

3. When the wireless device is connected, and the wired network is established, all LEDs turn on. The AP-100AH will be ready to use. You can use 802.11ah wireless devices through the AP-100AH.

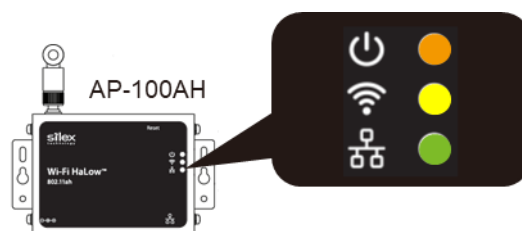

3-2. Configuration Using AMC Manager[®]

How to configure AP-100AH using AMC Manager[®] is explained.

Connecting AP-100AH to a computer

1. Connect AP-100AH and the PC (to use for setup) using a network cable.

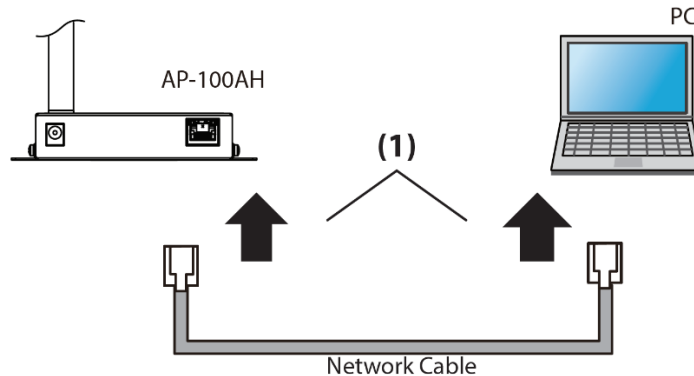

2. Connect the AC adaptor to AP-100AH, and the AC adaptor's plug to an electrical outlet.

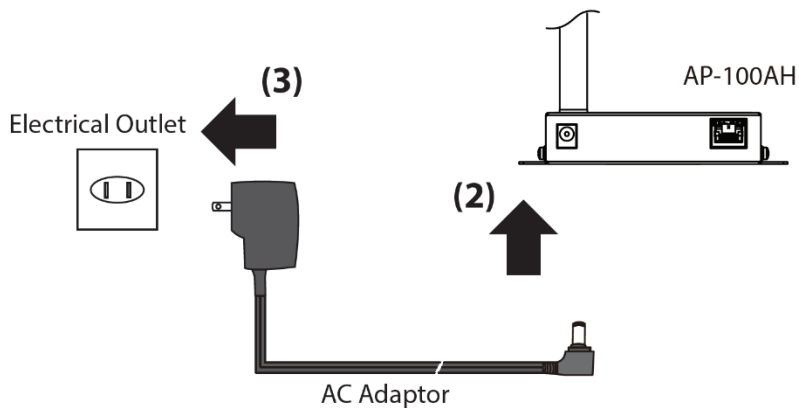

3. Confirm that the Power LED (orange: (2)) and the wired LED (green: (4)) are turned on.

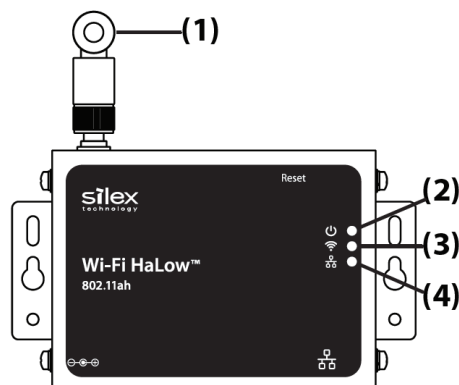

Configuration

1. Download AMC Manager® from the Silex Technology's website and install it to your computer. Launch AMC Manager® and confirm AP-100AH is found.

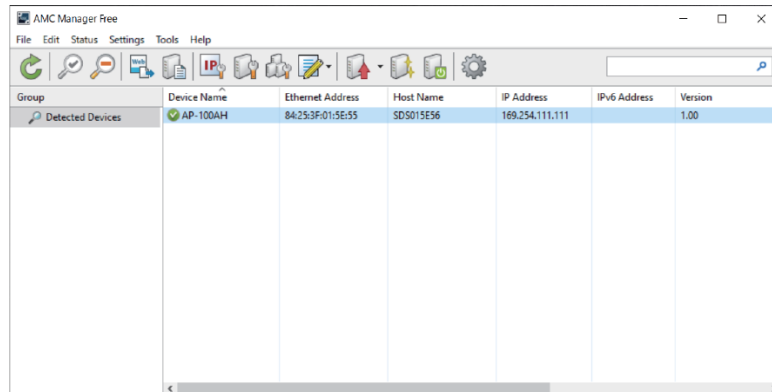

TIP

- To start the configuration, the PC and AP-100AH need to communicate each other properly.
- Confirm that an IP Address is correctly configured to the PC.
- If a static IP address is set to the Ethernet adapter of the PC, the Web configuration interface cannot be displayed in the following cases:
 - An IP address of the Ethernet adapter is set for a different subnet.
- If the AP-100AH configuration web page does not appear, set the IP address of the Ethernet adapter of the PC connected with the AP-100AH as following:
 - IP Address: 169.254.111.1
 - Subnet Mask: 255.255.0.0

2. Create a configuration file using the template. Click the icon **Create the configuration file** and click **Create from Template** from the toolbar (1). In the **Select Template** window, select the device to configure and click **OK** (2).

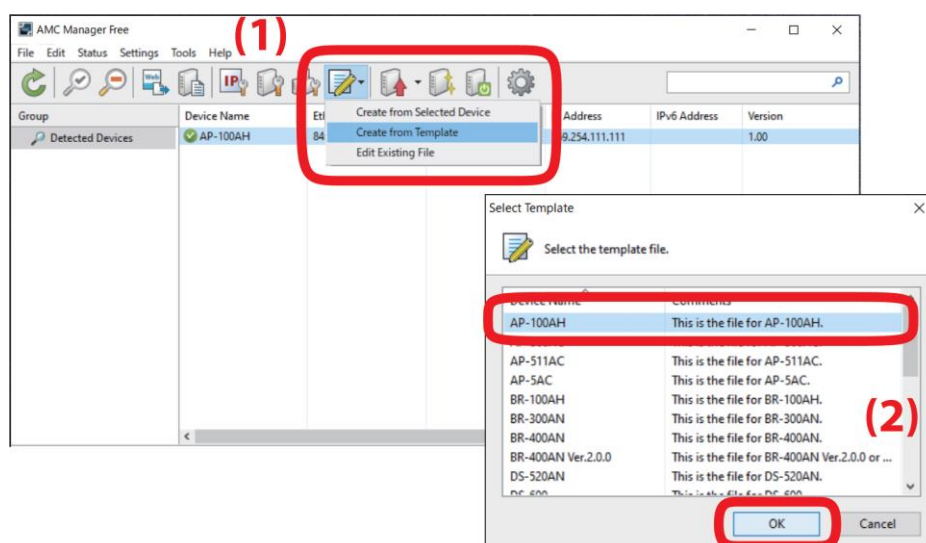

- In the **Create Configuration File** window, check the check box of the items you want to use for the configuration file, edit the settings, and click **Save**. In the dialog to save the configuration file, specify the file name and click **Save**. The password shall be set for the first time configuration.

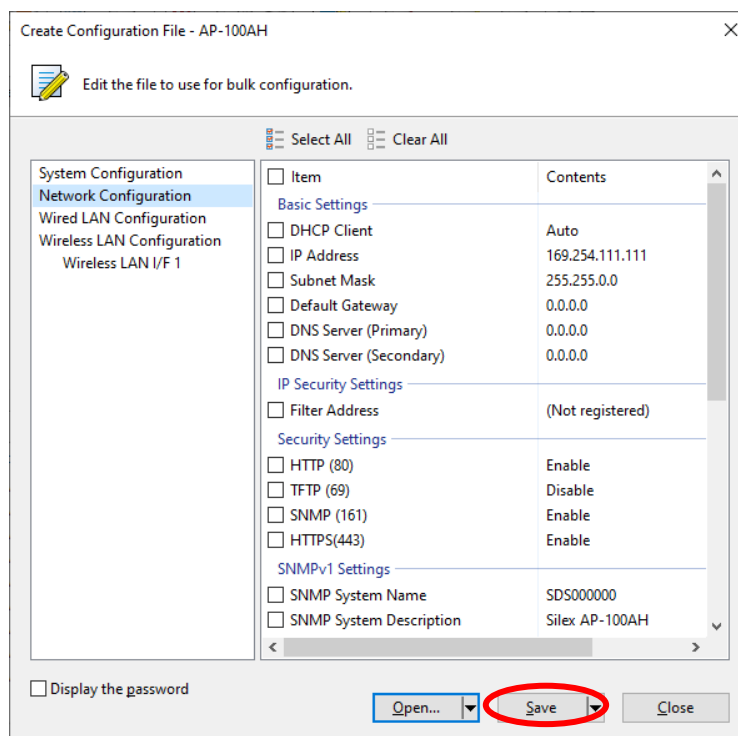
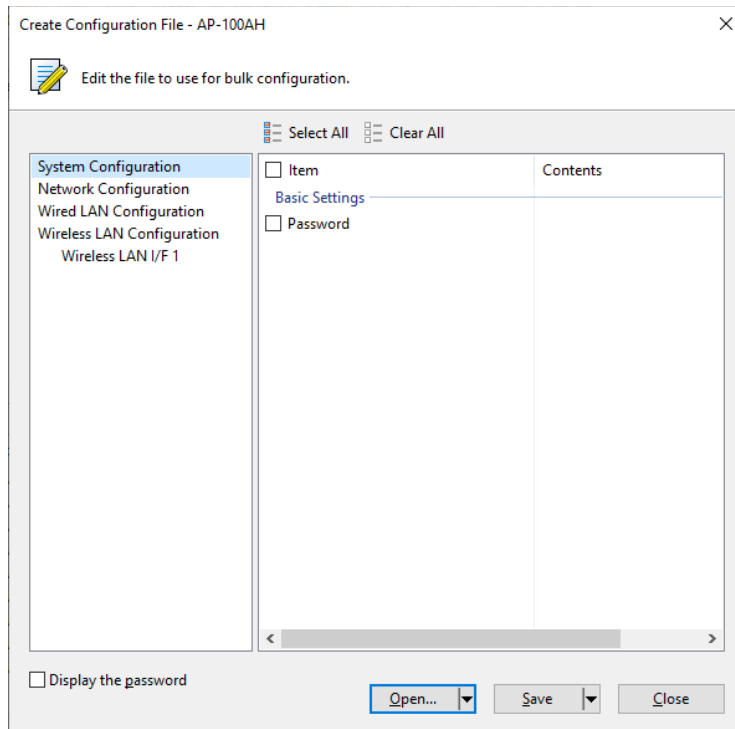

4. Select the AP-100AH unit to configure from the device list of AMC Manager®, and click the icon **Configure multiple devices in bulk**.

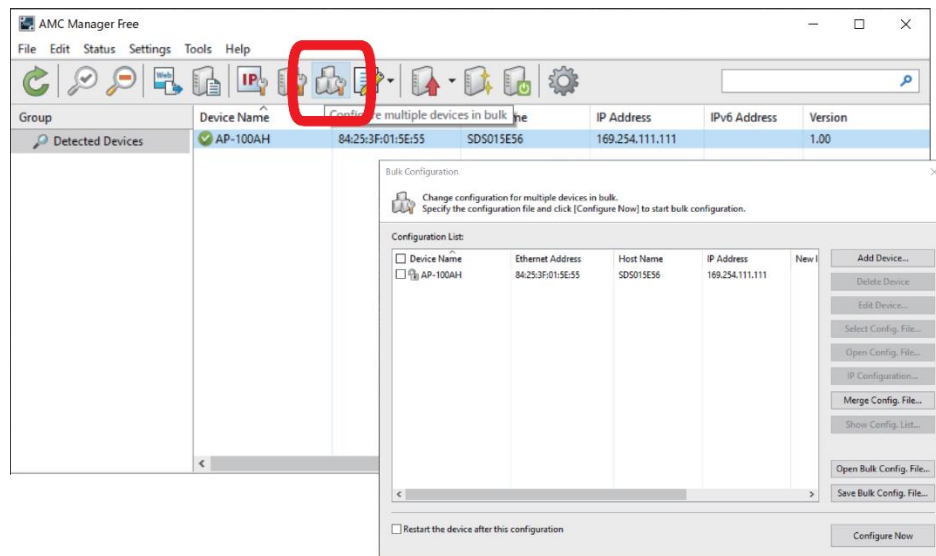

5. Select the AP-100AH unit to configure from the **Configuration List** (1) and click the **Select Config. File** button (2) in the **Bulk Configuration** window. When a file selection dialog appears, select the created configuration file and click **Open**.

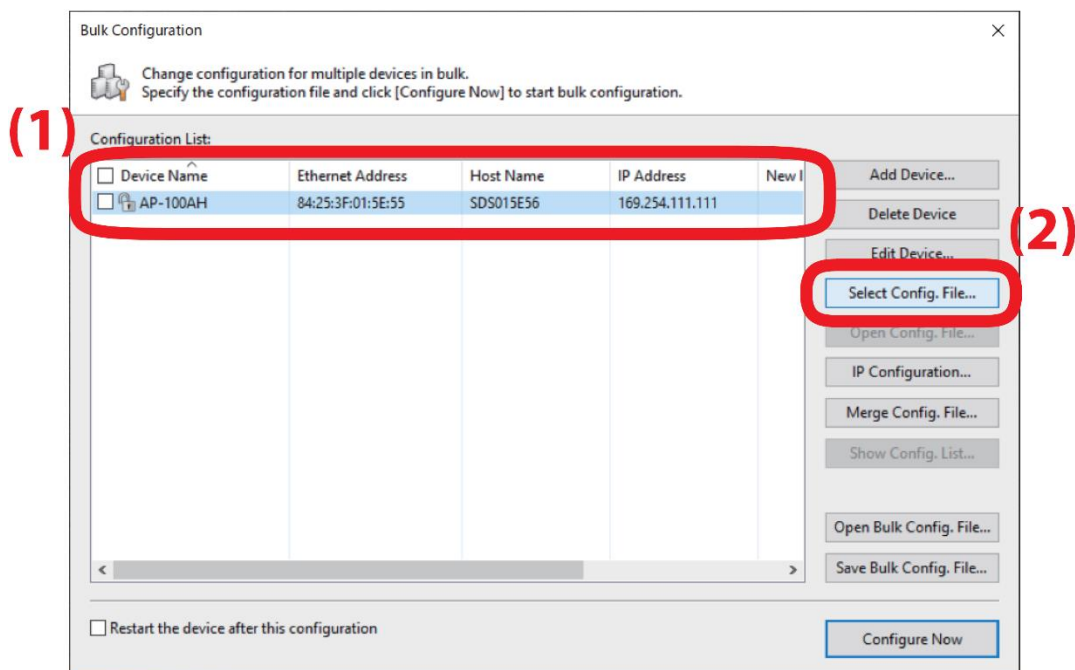

6. Check the check box of the AP-100AH unit to configure (1) and click **Configure Now** (2).

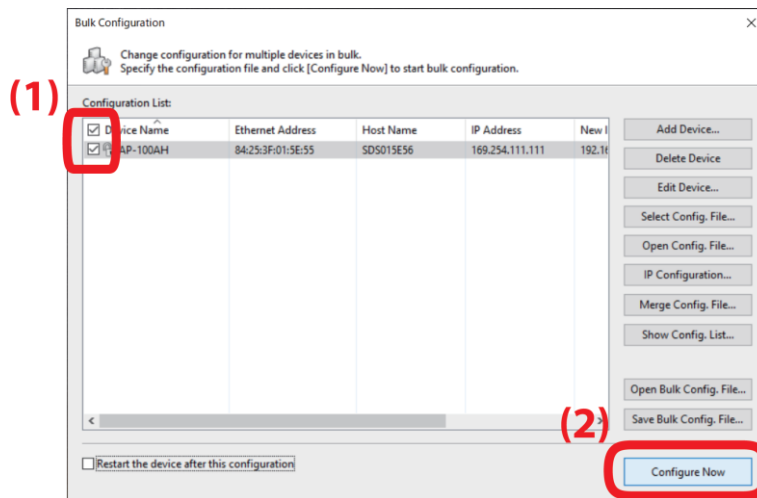

7. The configuration performs and the result is displayed. Click **Close**.

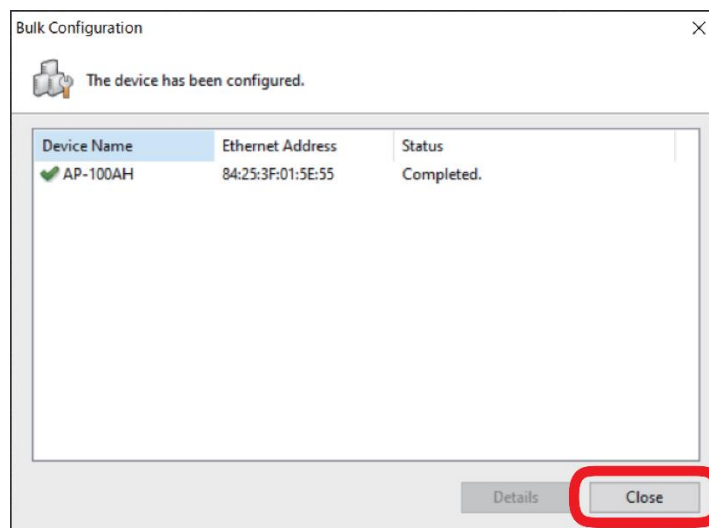

8. **Restart** the AP-100AH for your new configuration to take effect.

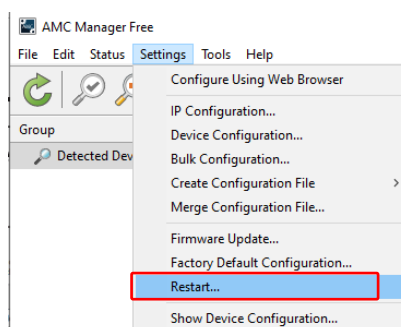

Connecting to Network

1. Connect the AP-100AH with an Ethernet HUB, switch, or a router. Note that the figure below only shows an Ethernet HUB, but it does not mean the AP-100AH works only with an Ethernet HUB.

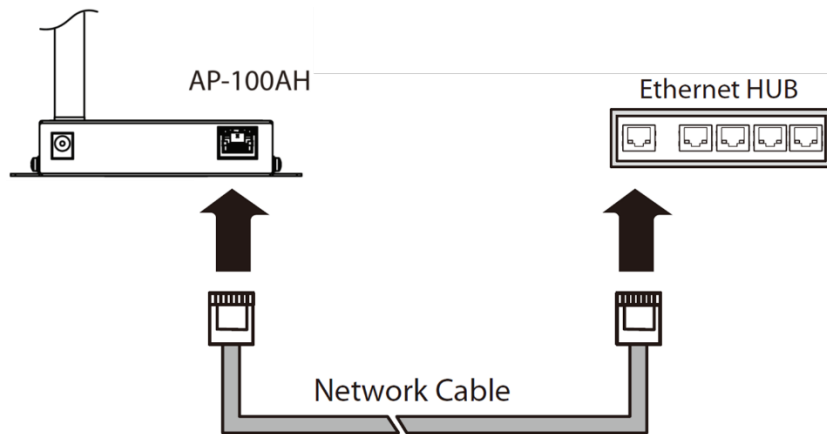

2. Connect the AC adaptor to the AP-100AH and the AC plug to the outlet.

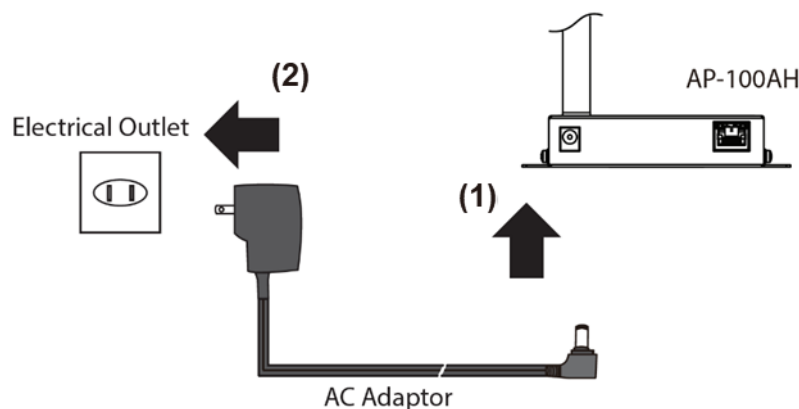

3. When the wireless device is connected and the wired network is established, all LEDs turn on. The AP-100AH will be ready to use. You can use 802.11ah wireless devices through the AP-100AH.

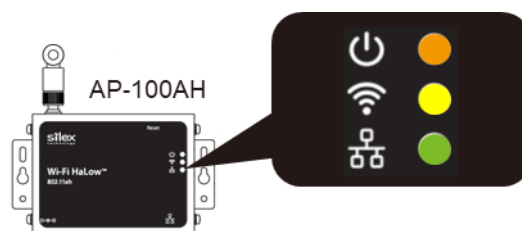

4. List of Functions

This chapter explains the AP-100AH functions.

4-1. DHCP Client

RFC2131/RFC2132 is supported to get an IP address, subnet mask, gateway address, DNS server address, and a default domain name from the DHCP server. To set an IP address with DHCP, a work station where the DHCP server is operating is required.

- When the DHCP client setting is "DHCP", address acquisition performs every 30 seconds when a DHCP server is not present in the environment.
- When the DHCP client setting is "AUTO", the configured IP address will be used if an address is not obtained when a DHCP server is not present in the environment.
- When the DHCP client setting is "AUTO" and IP address is obtained from a DHCP server, the configured IP address will not be used even when the lease period is expired, and this product tries to obtain an address from DHCP server.

DHCP client operates for the wired interface on the AP-100AH.

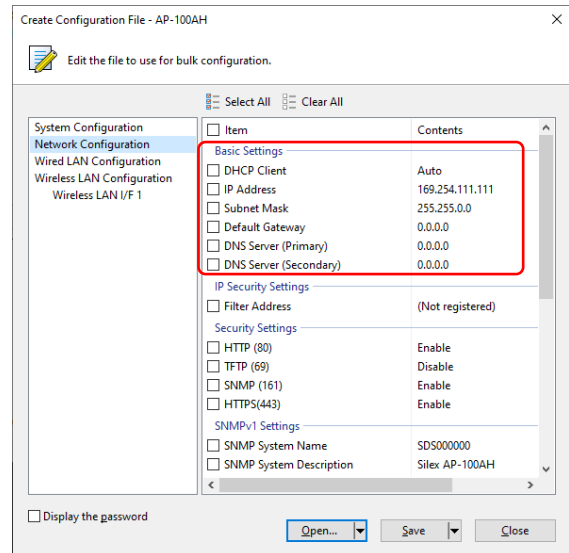
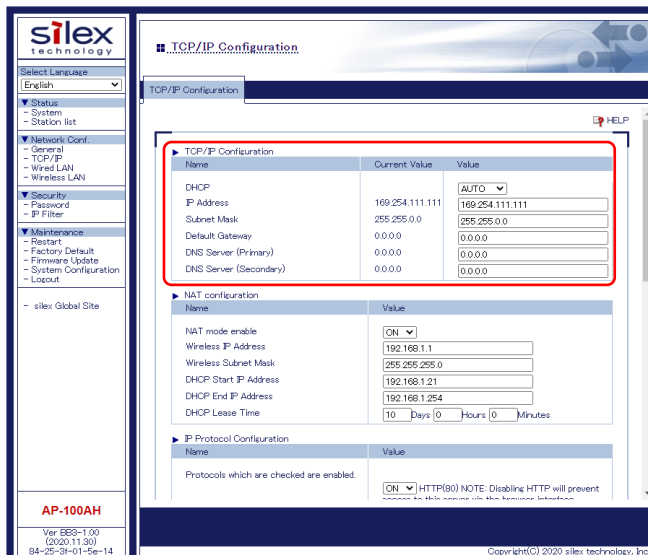

4-2. Network Address Translation (NAT)

This product equips the Network Address Translation (NAT) with a DHCP server function. When it is on, the AP-100AH acts as a router and enables a NAT. When disabled, the AP-100AH does not do any routing or address translations. In the latter case, if the clients are using a DHCP then there should be a DHCP server running on the wired network of the AP-100AH.

The function configures the following items:

- Start IP address
- End IP address
- Subnet mask
- Default gateway
- Lease time period

The NAT is useful when a large number of devices are deployed in your network. The AP-100AH establishes a private IP network with its DHCP server to save IPv4 address resources in your network. The NAT allows a device inside the private network to access your network.

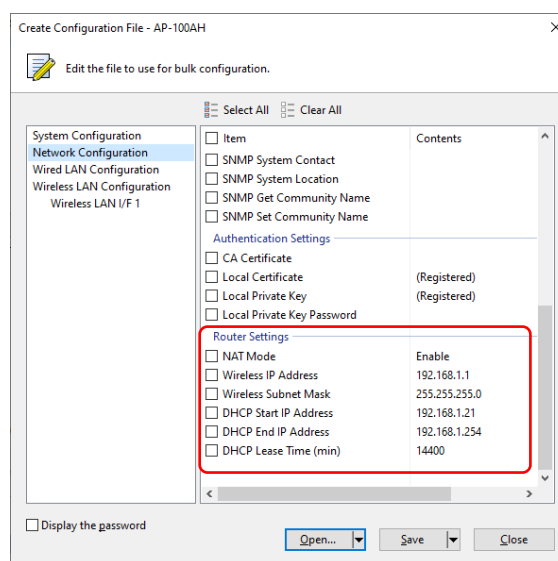
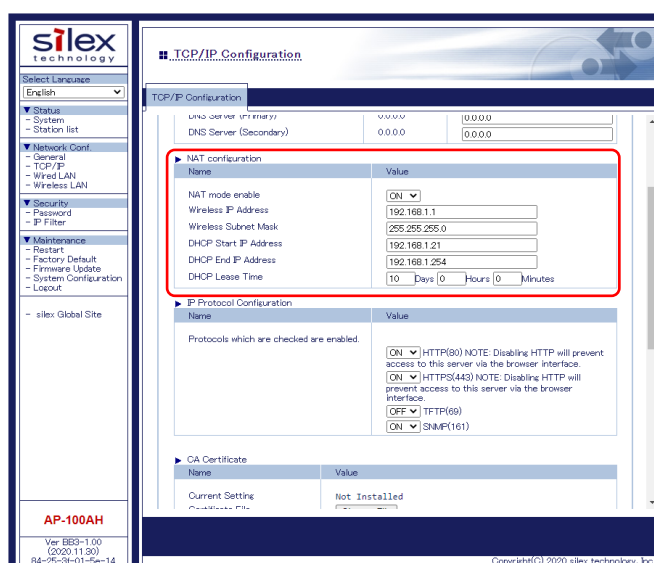
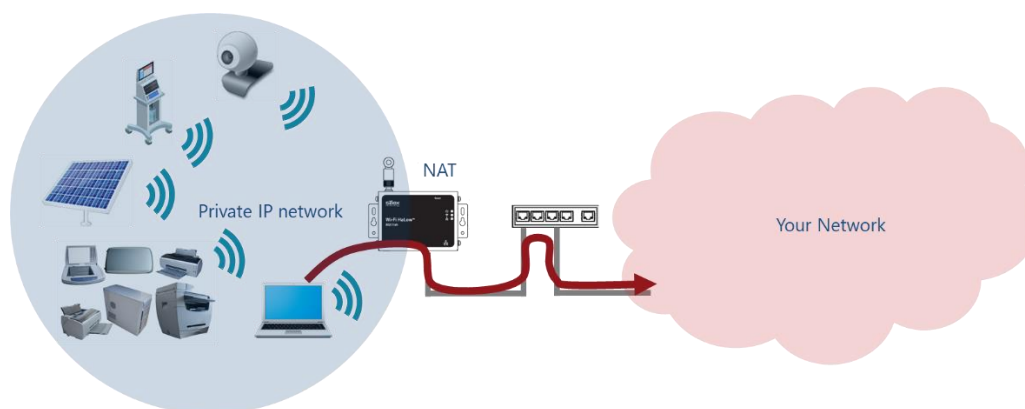

4-3. Radio Configuration

The AP-100AH allows users to select the **channel bandwidth**, the **channel**, and the **transmitter power**.

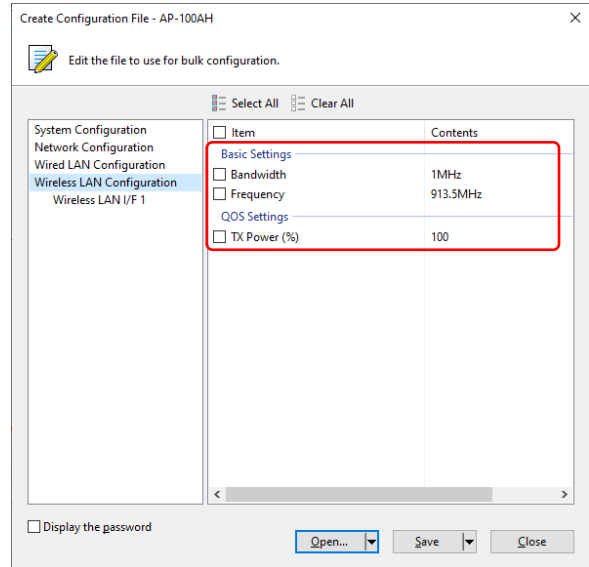
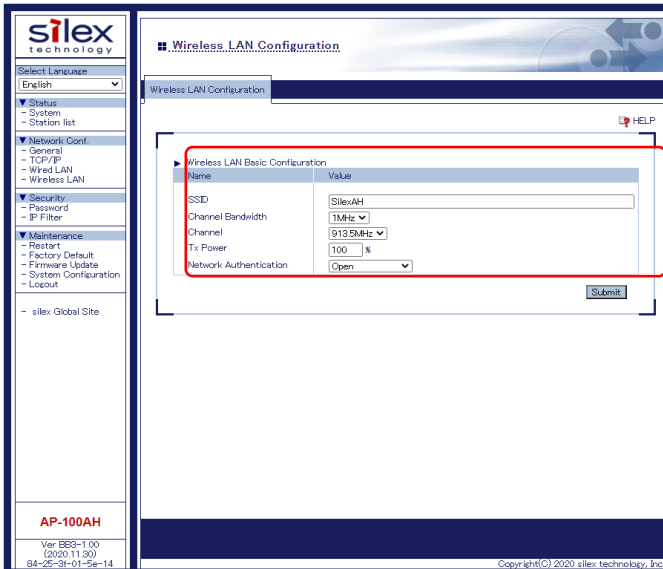

The channel bandwidth affects the data rate and the reach of wireless communication. The lower channel bandwidth is suitable for applications that require more extended reach with a lower data rate. When a higher data rate is required, the higher channel bandwidth increases the data rate while the distance becomes shorter. The table below shows the theoretical data rate in each channel bandwidth with the short GI (Guard Interval). Note that MCS (Modulation and Coding Scheme) is automatically

MCS Index	Data Rate		
	1MHz	2MHz	4MHz
MCS0	330 Kbit/s	720 Kbit/s	1.50 Mbit/s
MCS1	670 Kbit/s	1.44 Mbit/s	3.00 Mbit/s
MCS2	1.00 Mbit/s	2.17 Mbit/s	4.50 Mbit/s
MCS3	1.33 Mbit/s	2.89 Mbit/s	6.00 Mbit/s
MCS4	2.00 Mbit/s	4.33 Mbit/s	9.00 Mbit/s
MCS5	2.67 Mbit/s	5.78 Mbit/s	12.0 Mbit/s
MCS6	3.00 Mbit/s	6.50 Mbit/s	13.5 Mbit/s
MCS7	3.34 Mbit/s	7.22 Mbit/s	15.0 Mbit/s
MCS10	170 Kbit/s	N/A	N/A

The use of 925.5 MHz and 926.5MHz is not recommended as per the AP-100AH's implementation. Please refer to an application note in the link below for more details.

https://www.silxtechnology.com/hubfs/Application%20Notes/142-20159-100A_AppNote_SX-NEWAHChannelMapping_June2020_142-20142-100.pdf

4-4. IP Access Control

The AP-100AH can allow only specific devices to access it for the device configuration by "IP Access Control" function. The IP address range, which can access the AP-100AH for the configuration, can be set through the web configuration page or AMC Manager®.

For example, when the range is specified from 169.254.111.109 to 169.254.111.110, only devices with the IP address of 169.254.111.109 and 169.254.111.110 can access the AP-100AH through web configuration page or AMC Manager®. The IP address range can be removed when it is not necessary.

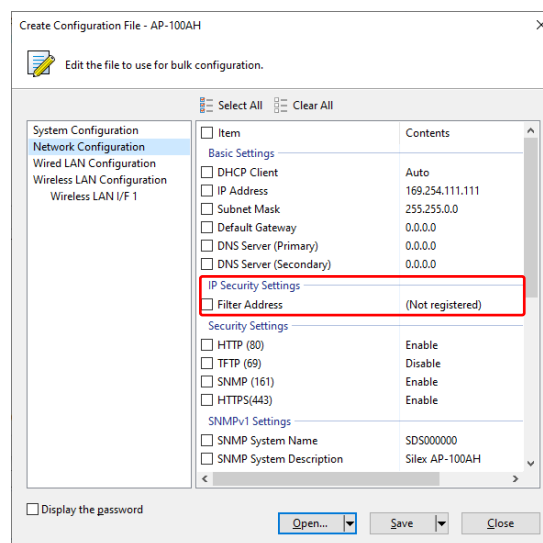
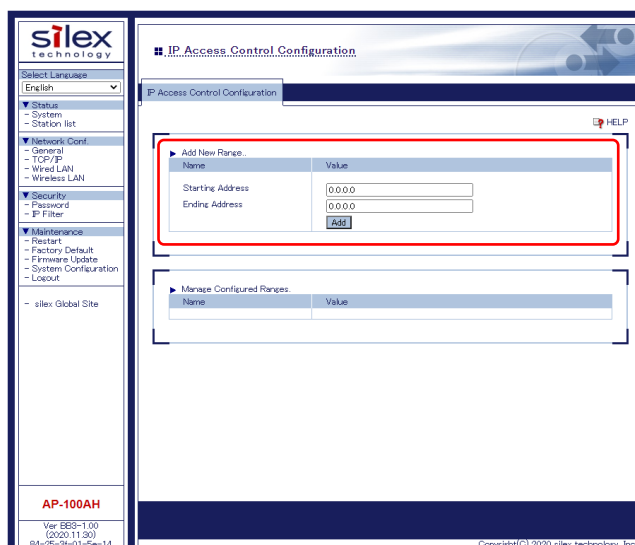

4-5. Web (HTTP/HTTPS)

The AP-100AH has web pages for settings. Various settings can be made from the web page. The AP-100AH can also be restarted or reset to the factory setting through the web page. Enter `http://169.254.111.111` (the IP address of AP-100AH's Ethernet port) on your web browser when the computer is connected to the AP-100AH through the Ethernet port. The scheme "https://" is available when HTTPS is enabled. If HTTP is disabled, `http://` accesses are redirected to `https://` URLs.

The AP-100AH supports TLS version 1.0/1.1/1.2. A self-signed certificate is alternatively applied if a server certificate is not set. CA certificate, local certificate and local private key can be loaded to secure HTTPS connection for the device configuration.

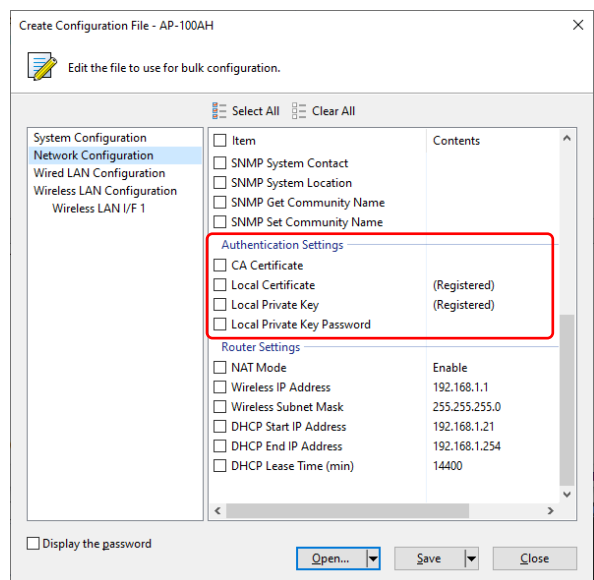
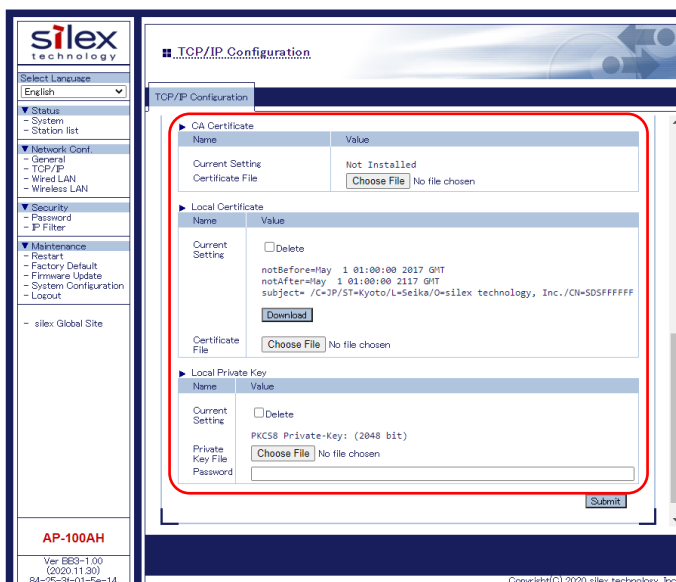

4-4. Maintenance

Restarting

How to restart AP-100AH by unplugging the AC adaptor:

1. Unplug the AC adaptor of AP-100AH from the outlet.

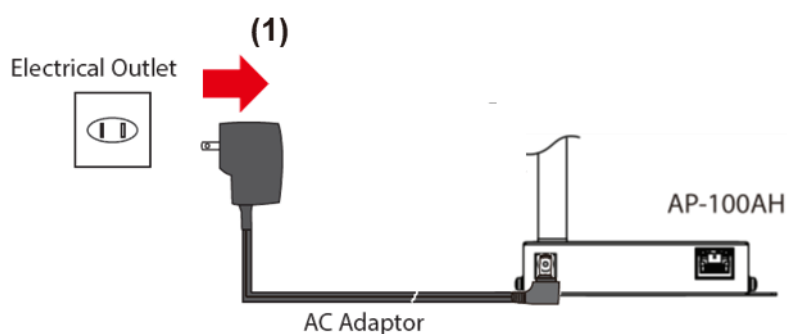

2. Plug the AC adaptor back into the outlet.

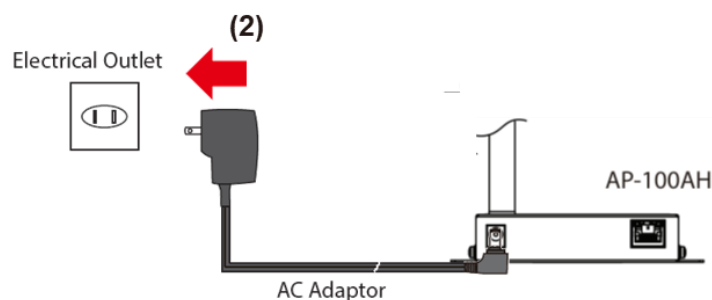

3. When the POWER LED turns on, the restart is completed.

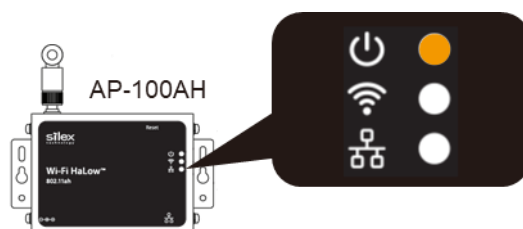

How to restart AP-100AH using the Web configuration interface:

1. Login to the Web configuration interface using your web browser.

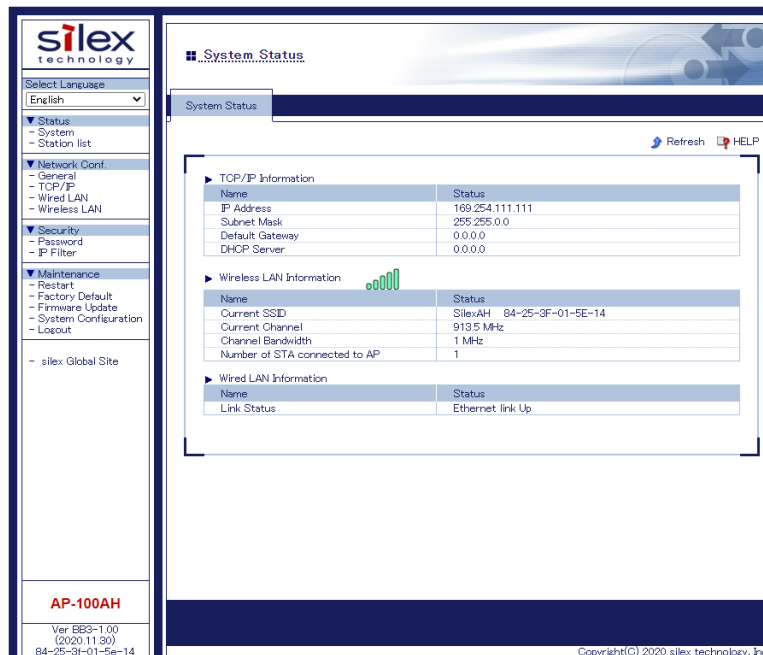

2. From the left menu on the Web configuration interface, click **Maintenance - Restart**. In the page displayed, click **Yes**.

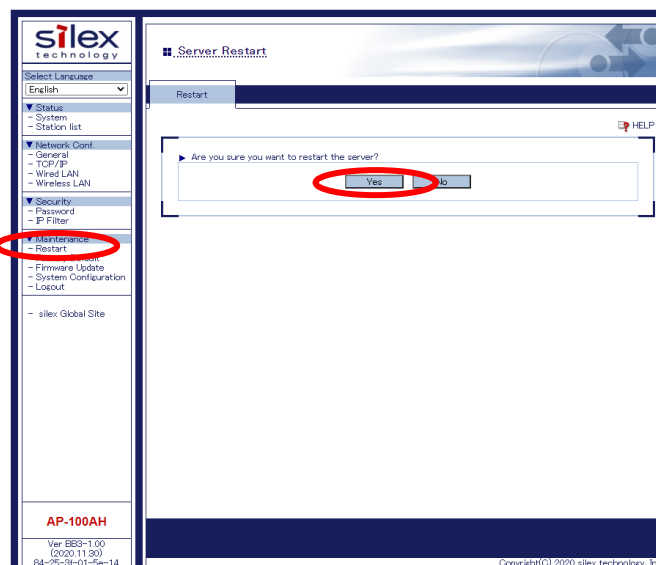

How to restart AP-100AH using AMC Manager®:

1. Right click the AP-100AH to restart and click **Restart**.

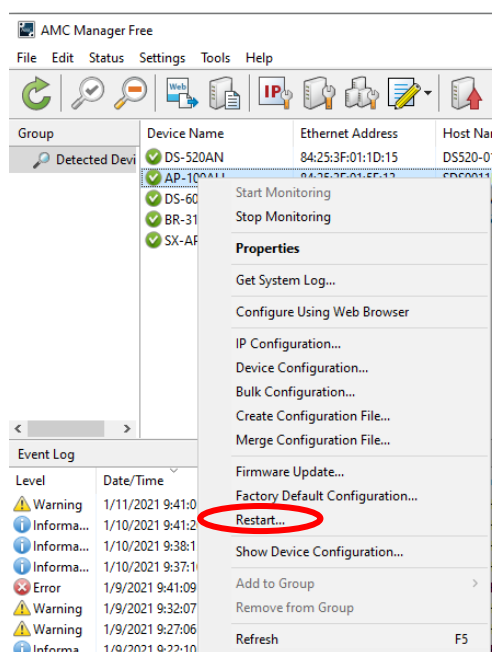

2. Click **Restart**. The pop-up window appears, then click **Yes**.

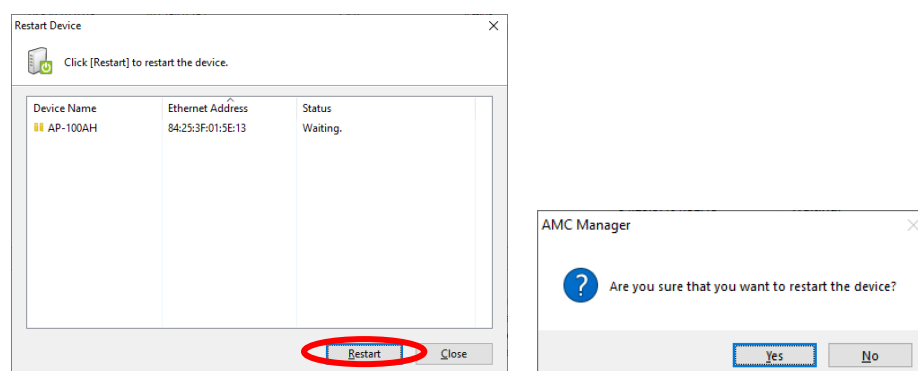

3. Enter the password for the AP-100AH and click **OK**. When the restart finishes, **Status** changes to **Completed**. (Password window appears only when the password is set.)

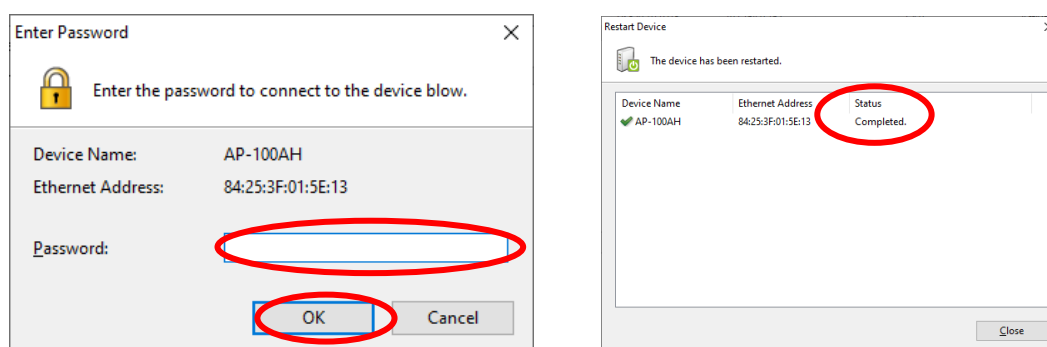

Factory Default Configuration

The AP-100AH can be reset to the factory default configuration except for the parameters listed in the table below:

Item name	Default value
General - General Settings	
System description	“Silex AP-100AH” or “Silex AP-100AH”
TCP/IP - CA Certificate	
Certificate File	None
TCP/IP - Local Certificate	
Certificate File	Self-signed Certificate
TCP/IP - Local Private Key	
Private Key File	Automatically generated
Password	None
Maintenance	
Firmware	Ver BB3-1.00 (2020.11.30)

How to reset AP-100AH to factory defaults using the Push Switch:

1. Press and hold the push switch on the back side of the AP-100AH for more than 5 seconds, and release it while the AP-100AH is powered on.
Confirm that LEDs except for the power LED turns off after releasing the push switch.

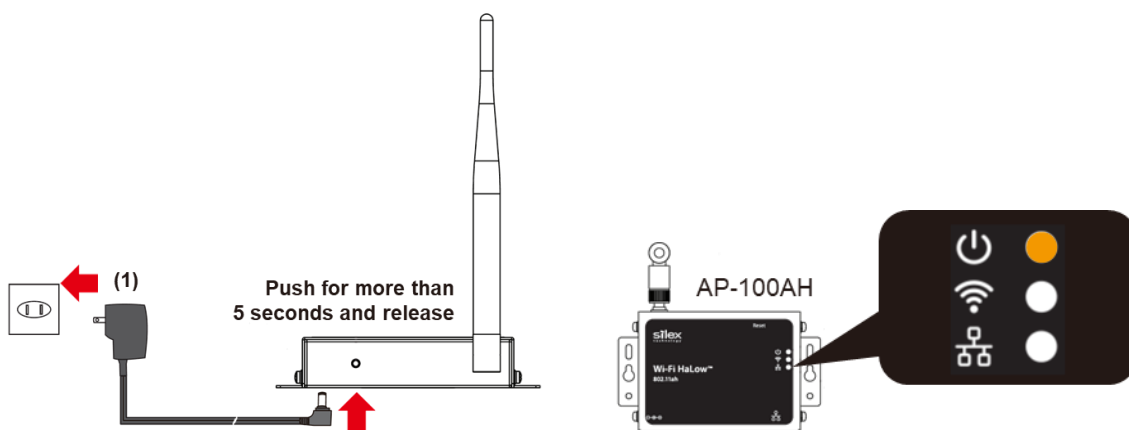

How to reset AP-100AH to factory defaults using the Web configuration interface:

1. Login to the Web configuration interface using your web browser.

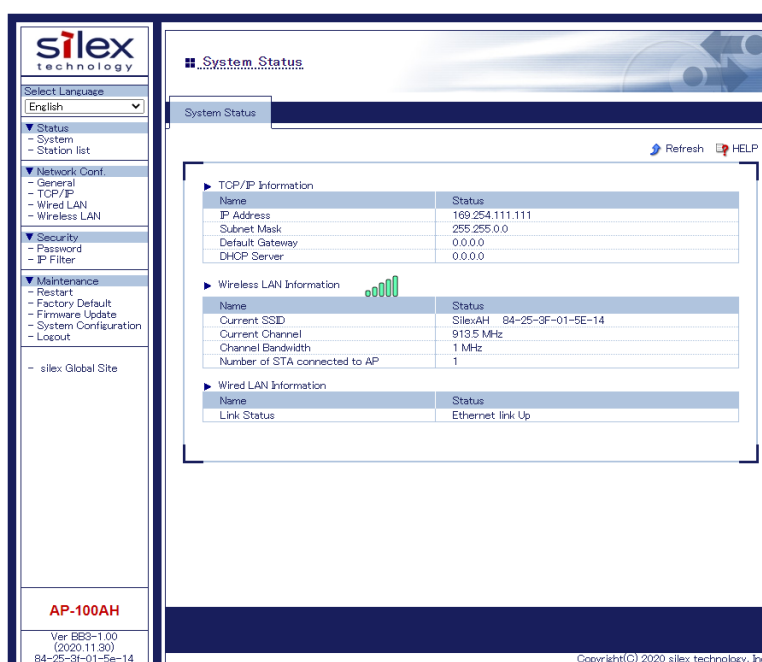

2. From the left menu on the Web configuration interface, click **Maintenance – Factory Default**. In the page displayed, click **Yes**.

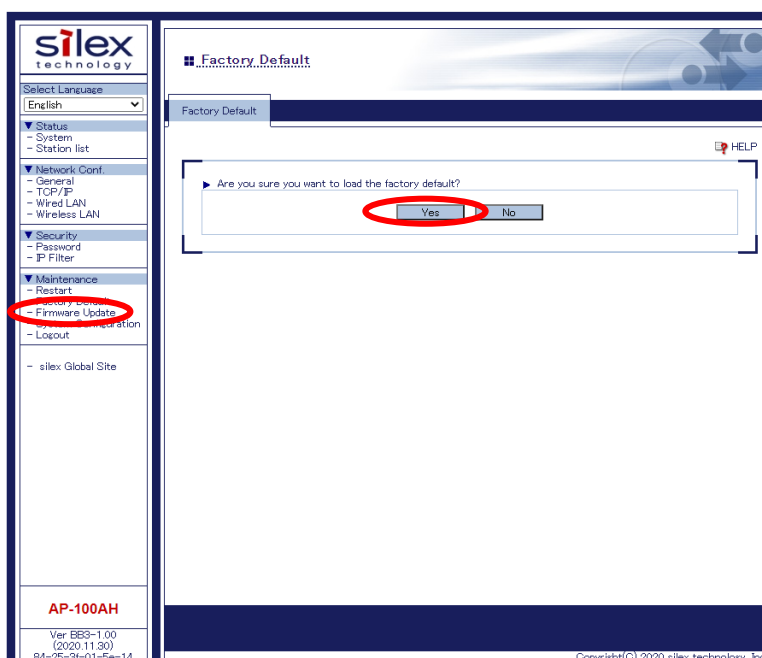

3. After the factory default configuration is completed, the AP-100AH will automatically restart. The web configuration page can be accessible again through the Ethernet port by 169.254.111.111.

How to reset AP-100AH to factory defaults using AMC Manager®:

1. Right click the AP-100AH to restart and click **Factory Default Configuration**.

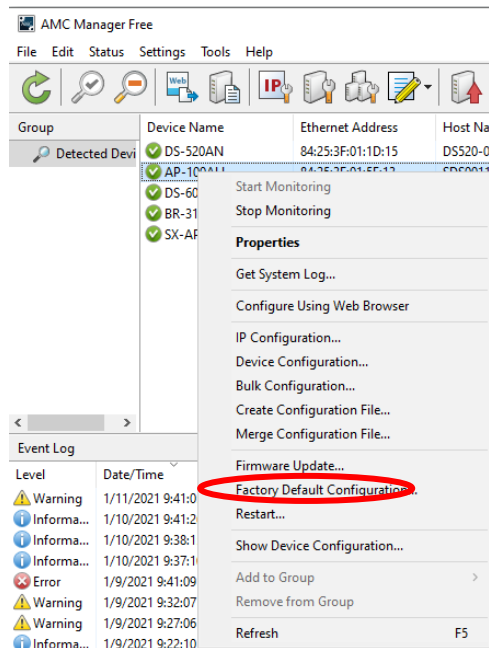

2. Check the check box of **Restart the device after the factory default configuration**, and click **Reset**. The pop-up window appears, then click **Yes**.

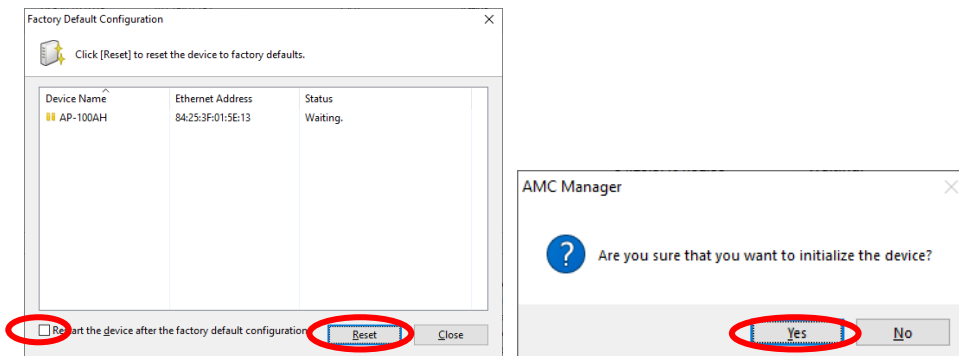

3. Enter the password for the AP-100AH and click **OK**. When the restart finishes, **Status** changes to **Completed**.

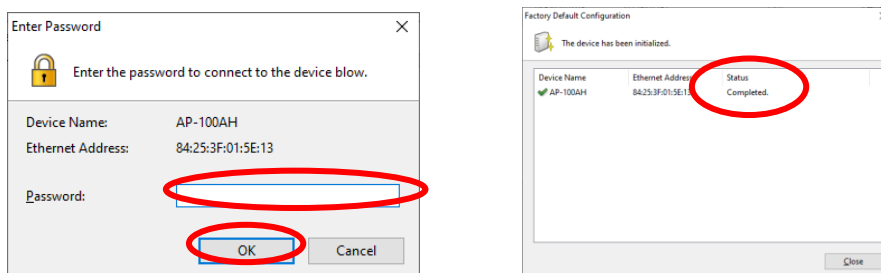

Firmware Update

The latest firmware file can be downloaded from our website.

See the instructions below to download the firmware file. For how to upload the firmware file to AP-100AH, refer to the firmware update procedure sheet file contained in the firmware file you download.



Note

- The current firmware version can be identified at the bottom left of the Web configuration interface.

Firmware Update Procedure:

1. Access our website below.

URL	
USA / Europe	https://www.silextechnology.com/connectivity-solutions/wifi-access-point/ap-100ah

2. Go to the support section and download the firmware file.
3. Extract the downloaded file to your folder. XXXX.bin (binary file) will be found.
4. Access the AP-100AH's web configuration page.

- If you don't know the IP address of the AP-100AH's wireless interface, AMC Manager® should find the IP address of AP-100AH's wireless interface.

The screenshot shows the AMC Manager Free interface. The main window displays a table of detected devices with columns for Device Name, Ethernet Address, Host Name, IP Address, IPv6 Address, Version, and Status. Below the table is an Event Log showing detection events for various devices.

Group	Device Name	Ethernet Address	Host Name	IP Address	IPv6 Address	Version	Status
Detected Devi	DS-S20AN	84253F011D15	D5520-011D15	192.168.0.163		1.4.0	Active
	AP-100AH	84253F015E13	S050011F8	192.168.0.4		1.0.0	Active
	BR-100AH	84253F015E35	S050011F8	192.168.0.37		1.0.0	Active
	DS-600	84253F1A25E3	D5600-1A25E3	192.168.0.3		1.4.1	Active
	BR-310AC	84253F20A664	S220A664	192.168.0.227		1.2.0	Active
	SX-AP-4800AN2	84253F4269B1	SX4269B1	192.168.0.12		1.1.1	Active

Level	Date/Time	Event	Device Name	Ethernet Address	Host Name	Details
Info...	1/29/2021 2:58:29 PM	Device detection	BR-300AH	84253F015E35	S050011F8	Device was found.
Info...	1/29/2021 2:58:08 PM	Device detection	BR-310AC	84253F20A664	S220A664	Device was found.
Info...	1/29/2021 2:58:07 PM	Device detection	SX-AP-4800AN2	84253F4269B1	SX4269B1	Device was found.
Info...	1/29/2021 2:58:07 PM	Device detection	AP-100AH	84253F015E13	S050011F8	Device was found.
Info...	1/29/2021 2:58:06 PM	Device detection	DS-600	84253F1A25E3	D5600-1A25E3	Device was found.
Info...	1/29/2021 2:58:06 PM	Device detection	DS-S20AN	84253F011D15	D5520-011D15	Device was found.

5. Login to the AP-100AH device configuration page.



6. Click **Firmware Update** and click **Choose File**. A pop-up window appears to select the firmware image. Please select the binary file found in step 3.

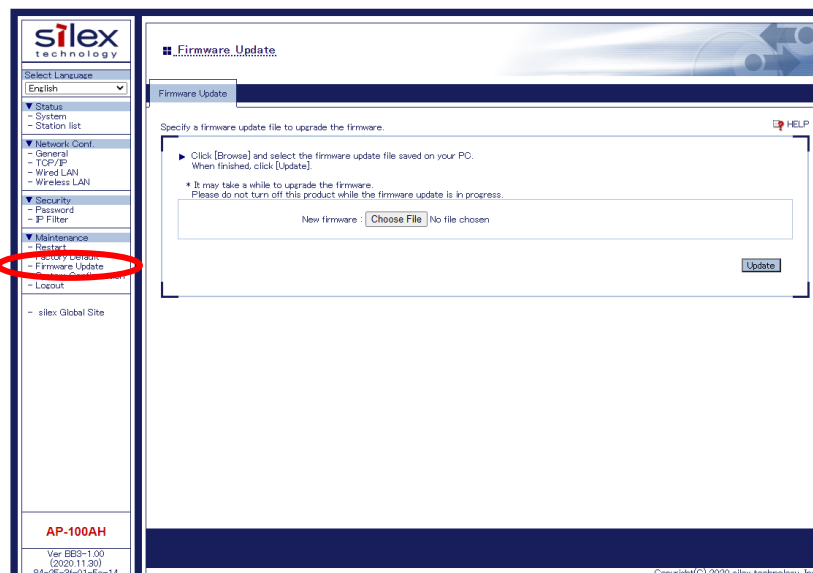

7. Click **Update** once the firmware binary file is selected.

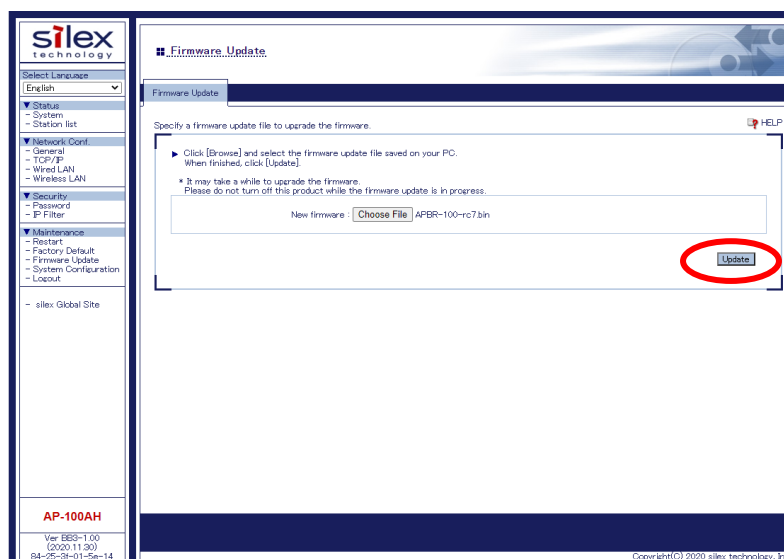

8. Click **OK**.

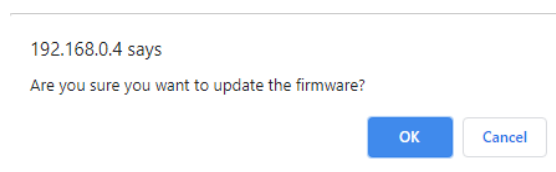

9. Please wait until the firmware update completes. Once it completes, the default page of the web configuration will appear.

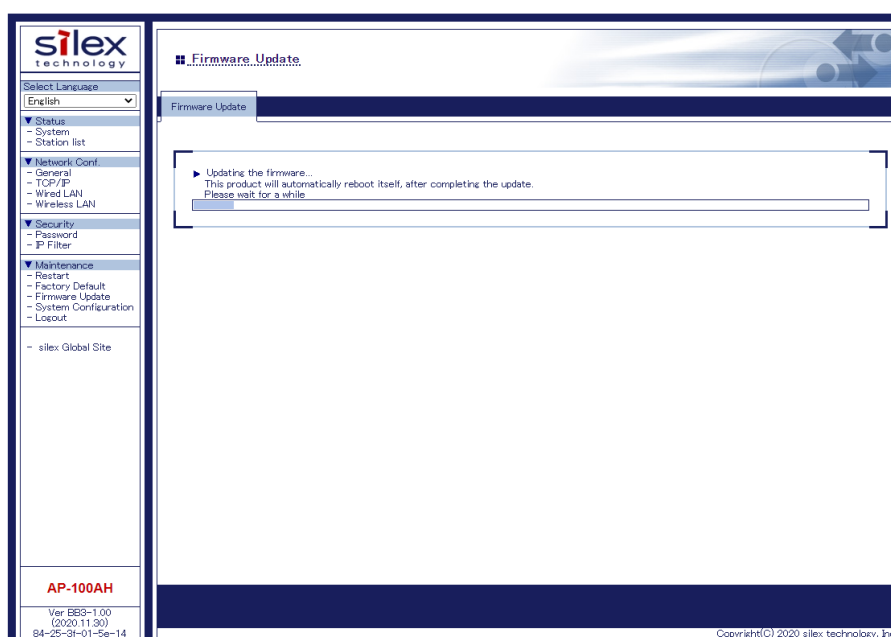

A. Appendix

A-1. List of All Settings

The AP-100AH has the following configuration items:

General Configuration – General Settings	
System Name	
Details	A name of the AP-100AH
Range	Maximum of 32 characters
Default Value	SDSxxxxxx
Note	"xxxxxx" is 3 bytes of the MAC address
System Description	
Details	Description of the AP-100AH
Range	Maximum of 64 characters
Default Value	Silex AP-100AH
System Contact	
Details	A contact to manage the system.
Range	Maximum of 63 characters
Default Value	<blank>
System Location	
Details	A location where the AP-100AH is installed
Range	Maximum of 16 characters
Default Value	<blank>
SNMP Get Community Name	
Details	A community name to be used to get SNMP information from the AP-100AH
Range	Maximum of 16 characters
Default Value	<blank>
Note	The value does not appear on the web page
SNMP Set Community Name	
Details	A community name to be used to set SNMP items of the AP-100AH
Range	Maximum of 16 characters
Default Value	<blank>
Note	The value does not appear on the web page

TCP/IP Configuration – TCP/IP Configuration	
DHCP	
Details	IP address setting method for the Ethernet port. To assign an IP address using DHCP, the DHCP server must be running in your subnetwork.
Range	AUTO/DHCP/STATIC
Default Value	AUTO
IP Address	
Details	Set the IP address of the wireless interface. If the DHCP is enabled on your network, the IP Address obtained from it will be applied.
Range	0.0.0.0 - 255.255.255.255
Default Value	169.254.111.111
Subnet Mask	
Details	Set the subnet mask of the wireless interface. If the DHCP is enabled on your network, the IP Address obtained from it will be applied.
Range	0.0.0.0 - 255.255.255.255
Default Value	255.255.0.0
Default Gateway	
Details	Set the default gateway IP address of the wireless interface. If the DHCP is enabled on your network, the IP Address obtained from it will be applied.
Range	0.0.0.0 - 255.255.255.255
Default Value	0.0.0.0
DNS Server (Primary)	
Details	Set the DNS primary server
Range	0.0.0.0 - 255.255.255.255
Default Value	0.0.0.0
DNS Server (Secondary)	
Details	Set the DNS primary server
Range	0.0.0.0 - 255.255.255.255
Default Value	0.0.0.0

TCP/IP Configuration – NAT Configuration	
NAT Mode Enable	
Details	Enable/Disable NAT functionality
Range	ON/OFF
Default Value	ON
Wireless IP Address	
Details	IP address of the AP-100AH's wireless interface.
Range	0.0.0.0 - 255.255.255.255
Default Value	192.168.1.1
Wireless Subnet Mask	
Details	Subnet mask for dynamic NAT
Range	0.0.0.0 - 255.255.255.255
Default Value	255.255.255.0
DHCP Start IP Address/End IP Address	
Details	Address range of IP address to be assigned to the wireless client devices when using Dynamic NAT.
Range	0.0.0.0 - 255.255.255.255
Default Value	192.168.1.21 – 192.168.1.254
DHCP Lease Time	
Details	The length of time the lease is valid for.
Range	0 – 99 days 0 – 23 hours 0 – 59 minutes
Default Value	10 days 0 hours, 0 minutes

TCP/IP Configuration – IP Protocol Configuration	
HTTP(80)	
Details	Enable/Disable HTTP protocol
Range	ON/OFF
Default Value	ON
Note	Disabling HTTP will prevent access to the AP-100AH web server via the browser interface
HTTPS(443)	
Details	Enable/Disable HTTP protocol
Range	ON/OFF
Default Value	ON
Note	Disabling HTTPS will prevent access to the AP-100AH web server via the browser interface
TFTP(69)	
Details	Enable/Disable TFTP protocol
Range	ON/OFF
Default Value	OFF
SNMP(161)	
Details	Enable/Disable SNMP protocol
Range	ON/OFF
Default Value	ON

TCP/IP Configuration - CA Certificate

Current Setting

Details	Information of a CA certificate imported to the AP-100AH. This certificate can be deleted.
Range	PEM Encoded X509 file
Default Value	Note installed

Certificate File

Details	Upload a CA certificate
Range	PEM Encoded X509 file
Default Value	Note installed

	<p>The certificate file must support the followings:</p> <ul style="list-style-type: none"> - File format <ul style="list-style-type: none"> PEM format(*.pem) - Public keyalgorithm <ul style="list-style-type: none"> RSA - Public key size <ul style="list-style-type: none"> 2048bit - Signature algorithm <ul style="list-style-type: none"> SHA-256 with RSA SHA-384 with RSA SHA-512 with RSA
--	--

TCP/IP Configuration - Local Certificate

Current Setting

Details	Information of a server certificate imported to the AP-100AH. This certificate can be deleted.	
Range	PEM Encoded X509 file	
Default Value	Self-signed certificate	
	Item	Description
	X.509 Certificate Version	v1
	Public Key Algorithm	RSA
	Public Key Length [bits]	2048
	Signature Algorithm	SHA256withRSA
	Common Name (CN)	SDSxxxxxx (from the System Name setting)
	Organization (O)	silex technology, Inc.
	Locality (L)	Seika
	State or Province Name (ST)	Kyoto
	Country Name (C)	JP
	Not Before	May 1 01:00:00 2017 GMT
	Not After	May 1 01:00:00 2117 GMT

Certificate File

Details	Upload a server certificate
Range	PEM Encoded X509 file
Default Value	Self-signed certificate
Note	<p>The certificate file must support the followings:</p> <ul style="list-style-type: none"> - File format PEM format(*.pem) - Public keyalgorithm RSA - Public key size 2048bit - Signature algorithm SHA-256 with RSA SHA-384 with RSA SHA-512 with RSA

TCP/IP Configuration – Local Private Key

Current Setting

Details	Information of a private key imported to the AP-100AH. This certificate can be deleted.
Range	PEM Encoded X509 file
Default Value	Automatically generated

Private Key File

Details	Upload a private key
Range	PEM Encoded X509 file
Default Value	Automatically generated

Password

Details	A password which protects the private key
Range	8 – 63 alphanumeric
Default Value	<blank>

Wired LAN Configuration – Wired LAN Basic Configuration

LAN Interface

Details	Configure the physical network type. Usually, " AUTO " is used.
Range	AUTO / 10 Half / 10 Full / 100 Half / 100 Full
Default Value	AUTO
Note	If a LINK LED on the connected device does not light on when AP-100AH is powered on, change the network type to that of the connected device.

Wireless LAN Configuration – Wireless LAN Basic Configuration

SSID

Details	SSID of wireless LAN that the AP-100AH connects
Range	1 – 32 characters (alphanumeric, hyphen, underscore)
Default Value	SilexAH

Channel Bandwidth

Details	A channel bandwidth used for the wireless LAN
Range	1MHz/2MHz/4MHz
Default Value	1MHz

Channel

Details	A frequency used for the wireless LAN
Range	Depends on selected “Channel Bandwidth”. Refer to section 2-3. Hardware Specification
Default Value	913.5MHz

Tx Power

Details	A transmitter power level used for the wireless LAN.
Range	5% - 100%
Default Value	100%
Note	100% is 23dBm. 50% is 11.5dBm.

Network Authentication

Details	An authentication method for connection with wireless clients.
Range	Open/Enhanced Open/WPA2-Personal/WPA3-Personal
Default Value	Open

Wireless LAN Configuration – WPA/WPA2 Configuration

Pre-Shared Key

Details	A Pre-Shared Key for AES-128
Range	WPA2: 8 – 63 characters password or 64 characters hexadecimal PSK WPA3: 8 – 63 characters password
Default Value	Device Server

Password Configuration

Password

Details	Configure the password to manage the AP-100AH. This password is used for authentication to login to the Web configuration interface of AP-100AH.
Range	Up to 8 characters
Default Value	(None)

IP Access Control Configuration – Add New Range

Starting Address/Ending Address

Details	An address range of the remote host IP to access the AP-100AH for its configuration.
Range	0.0.0.0 – 255.255.255.255
Default Value	0.0.0.0

A-2. Troubleshooting

This section provides the solutions for possible troubles you may experience when you are configuring or using the AP-100AH.

I cannot access the AP-100AH through a web browser and/or AMC Manager®

A computer may belong to a different network from the AP-100AH

Solution	Please check the IP addresses of the AP-100AH and the computer. If they are in the different network, please change the IP address of one of the AP-100AH and the computer.
----------	---

The IP address of the PC may be blocked by IP Filter function

Solution	Please try to change PC's IP address to be in the range of allowed IP addresses. If it is not practical to identify the IP address, please reset the product to the factory configuration with the push switch and reconfigure the AP-100AH.
----------	--

HTTP/HTTPS protocol may be disabled

Solution	If you cannot access the web configuration page, HTTP/HTTPS protocols may be disabled. Please access the AP-100AH with AMC Manager®.
----------	--

I cannot connect 802.11ah client devices to the AP-100AH

The client devices may use a different credential to connect with the AP-100AH.

Solution	Confirm that the SSID and the network authentication method in the client devices match with those set in the AP-100AH. If WPA2-Personal or WPA3-Personal is selected as the authentication method, make sure the Pre-Shared Key (PSK) is set correctly in the client devices.
----------	--

I cannot access 802.11ah client devices connected to the AP-100AH from my network

Your network may belong to a different network from the private network that the AP-100AH establishes with NAT function.

Solution	<p>(1) When you are trying to access your 802.11ah client devices from outside of the AP-100AH's private IP network, consider that you join the private IP network by connecting your device with the AP-100AH. If your computer does not have the 802.11ah wireless connectivity, silex technology offers BR-100AH to add 802.11ah wireless connectivity through an Ethernet port of your computer.</p> <p>(2) When you do not need to establish the private IP network using the AP-100AH's NAT function, disable the NAT function and assign the IP address statically or through a DHCP server on a wired network of the AP-100AH.</p>
----------	--